

My Mother Sews

Designed by Jean Katherine Smith
From Improv Quilt Design Studio
Featuring the McCall's Collection by McCall's
Size: 63" X 76"



Feel free to download additional copies of this and other projects by visiting our website: www.windhamfabrics.com

WINDHAM FABRICS







812 Jersey Ave ~ Jersey City, NJ 07310 ~ 201.659.0444 ~ FAX: 201.659.9719
www.windhamfabrics.com email: retail@windhamfabrics.com

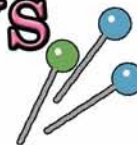

My Mother Sews

Designed by Jean Katherine Smith
 From Improv Quilt Design Studio
 Featuring the McCall's Collection by McCall's
 Size: 63" X 76"







Fabric Picture	Quantity	Fabric Number	Placement of Fabric	Cutting
	1 1/2 yards	33500-X	Center Panel	This is cut as a solid piece long ways: 1 - 9 1/2" x 50 1/2" LOF The remaining fabric (30" x 54") is used as backing.
	2 yards	33501-X	Wide Border	2 - 57 1/2" x 6 1/2" LOF 2 - 44 1/2" x 6 1/2" WOF Cut 2 strips then add the extra few inches from the leftovers from cutting the long strips. The remaining fabric is used as backing.
	1 1/4 yards	33502-1	Background for Appliqué Corner Squares	4 - 12 1/2" x 21 1/2" 4 - 6 1/2" squares Friends - Cut with seam allowance on the lighter line (Not Fused): 2 of D, E, G, I 4 of B
	5/8 yard	33503-X	Narrow Border Corner Squares	Cut 7 - 2 1/2" strips and make into: 2 - 2 1/2" x 59 1/2" 2 - 2 1/2" x 72 1/2" 4 - 2 1/2" squares
	1/8 yard	33506-3	Appliqué Pieces	From fabric with Fusible Web cut. Sewing Machine pieces: 2 each - B, D, E, G, I, L. Spools of Thread: 2 of H Large Buttons: 2 of G Small Buttons: 4 of G
	3/8 yard	33506-4	Appliqué Pieces	From fabric with Fusible Web cut; Sewing Machine pieces: 2 of F Spools of Thread: 2 of G Large Buttons: 2 of E Small Buttons: 4 of E

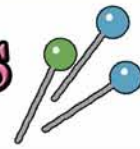

My Mother Sews

Page 2

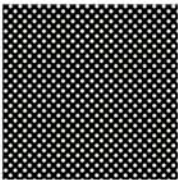

	1/2 yard	33506-5	Narrow Border Pieced Friends Appliqué Pieces	Cut 5 – 2" strips and make into: 2 – 2" x 50 1/2" 2 – 2" x 37 1/2" Friends - Cut with seam allowance on the lighter line (Not Fused): 4 of C, F, H From fabric with Fusible Web cut: Spools of Thread: 2 of C Large Buttons: 2 of F Small Buttons: 4 of F Scissors: 2 each F, G
	3/4 yard	33506-6	Binding Appliqué Pieces	Cut 7 – 2 1/4" strips for binding From fabric with Fusible Web cut Sewing Machine pieces: 2 each - C, H, J, M, K, N Spools of Thread: 2 each - B.D. E. F. I, J Large Buttons: 2 each - B, C, D Small Buttons: 4 each - B, C, D Scissors: 2 each - B, C
	1/2 yard	33507-3	Outer Border	Cut 7 – 2" strips and make into: 2 – 2 x 59 1/2" 2 – 2 x 69 1/2"
	5/8 yard	33507-5	Inner Border	Cut 7 – 2 1/2" strips and make into: 4 – 2 1/2" x 50 1/2" 2 – 2 1/2" x 37 1/2"

Additional Material Needed:

- 2 1/4 yards fabric for backing plus using the rest of fabrics 1 and 2
- 70" x 82" quilt batting
- 1 to 1 1/2 yards of Fusible Web

Cutting the Fabric

Measurements include 1/4" seam allowances.

All cuts are the width of the fabric unless otherwise indicated. LOF = Length of Fabric

Cut apart appliqué pattern pieces and sort by fabric. Arrange on fabric to determine how much fabric needs to have fusible webbing applied. Iron fusible webbing to wrong side of fabric. Pin pattern pieces to right side of fabric and cut out shapes. Arrange on background fabric, remove backing and iron in place. Cut out scissor handle holes. The letter A on the appliqué patterns indicates background fabric.



My Mother Sews

Page 3



Making the Quilt

1. Arrange cut appliqué pieces on background fabric. Iron in place.

Make 2



Make 2



Make 4



2. Construct pieced Friends units as follows. Make two units.

Press seams open.

Sew top strips together: B, F, G, F, B

Sew two pink arms together: C and C

Sew bottom unit together: E, H, I, H, D

Sew all three units together.



3. Sew panels together. See diagrams.



4. Sew pink striped strips to each side of panels. Add middle panel. Press seams toward stripe sashing.



WINDHAM FABRICS



My Mother Sews

Page 4

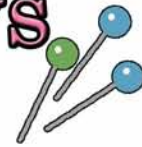

5. Sew black corners to pink and black stripe. Make two. Sew to top and bottom of center.



6. Add the pink strip to all four sides.
7. Add corner pieces with buttons to the two shorter wide borders.
Sew longer border pieces to the sides, then the top and bottom border pieces matching seams.



8. Add blue striped narrow border to four sides.
9. Add black narrow border to four sides

Finishing the Quilt

1. Make backing to fit quilt size plus 3 inches on each side.
2. Layer backing, batting, and quilt top. Use temporary fabric spray adhesive for basting. Quilt as desired.
3. Join 2 1/4 " wide strips into 1 continuous piece for straight-grain French-fold binding. Fold lengthwise and press. Trim and square quilt. Sew binding to quilt with a quarter inch seam. Either hand stitch in place; or turn, press, and machine stitch in the ditch.

**Always look on our website before starting your project to see
if there are any updates or corrections**

Be sure to visit www.windhamfabrics.com to see the complete collection
and to download this and other Free Projects

WINDHAM FABRICS





Friends For Life

Key Block (31/50 actual size)

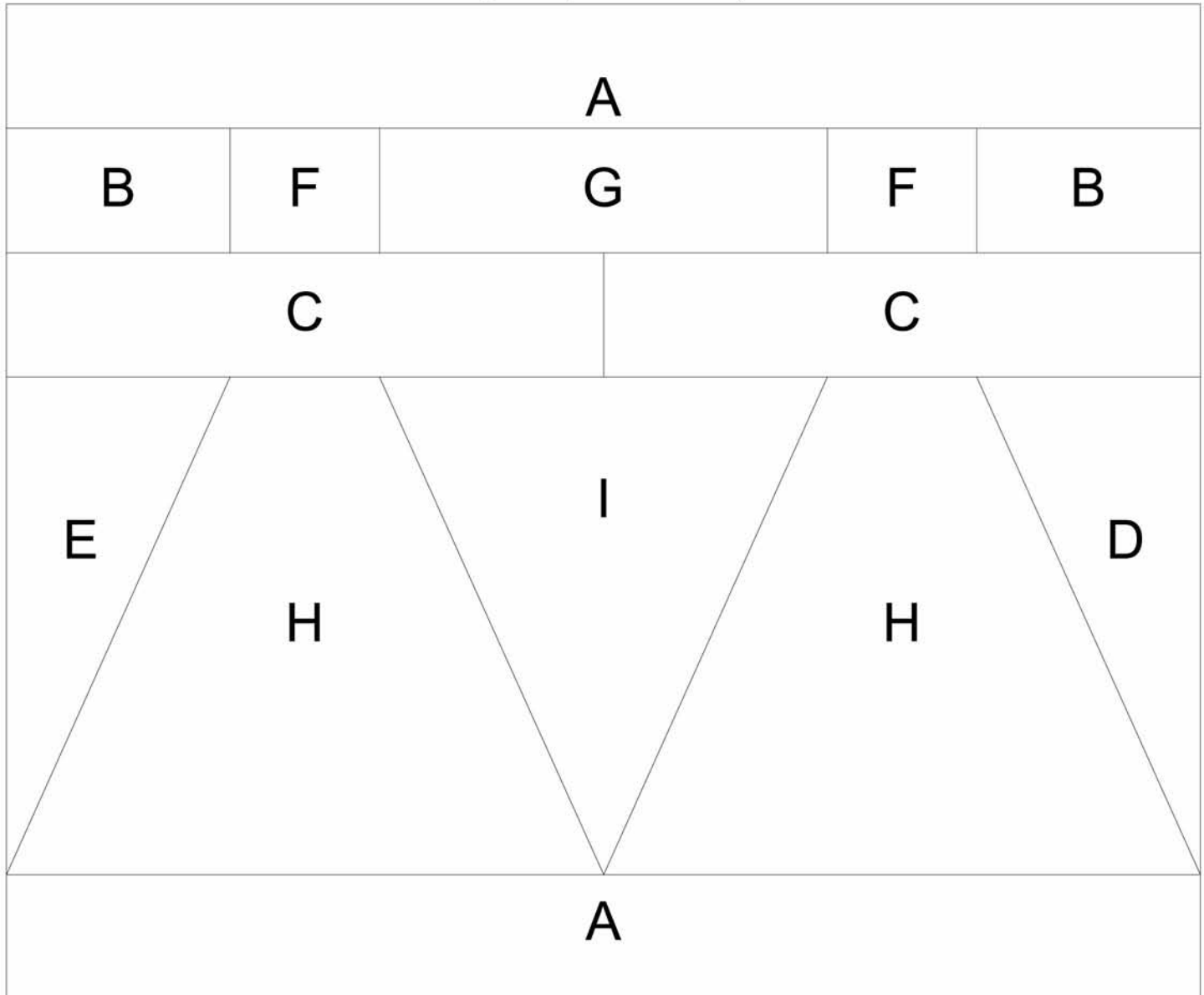

My Mother Sews

Page 6

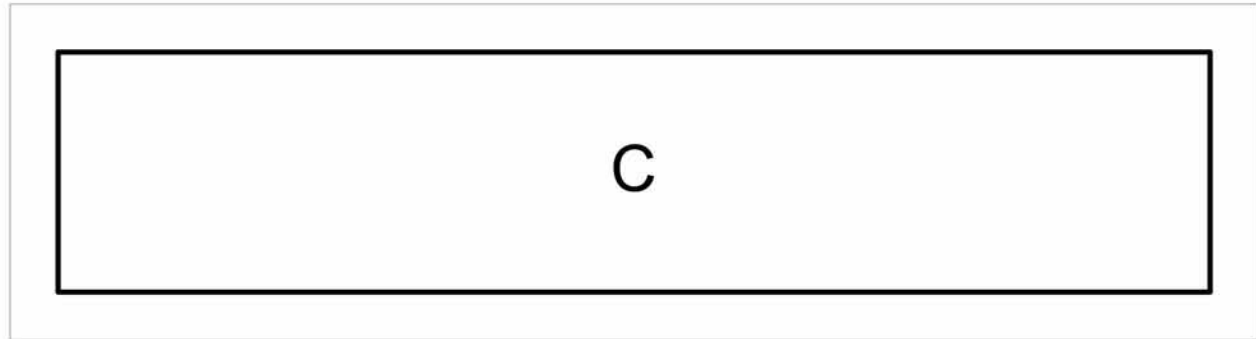
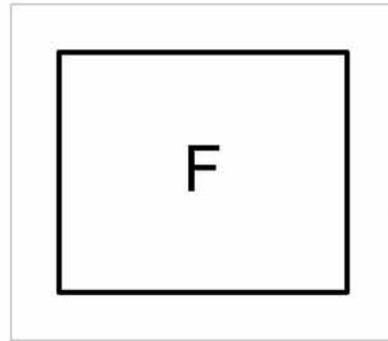
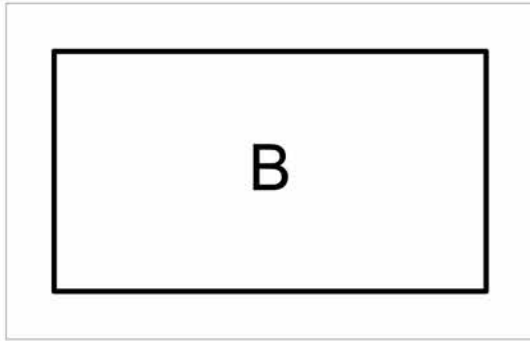

TEMPLATES
DO NOT size to fit paper.
Templates are actual size.

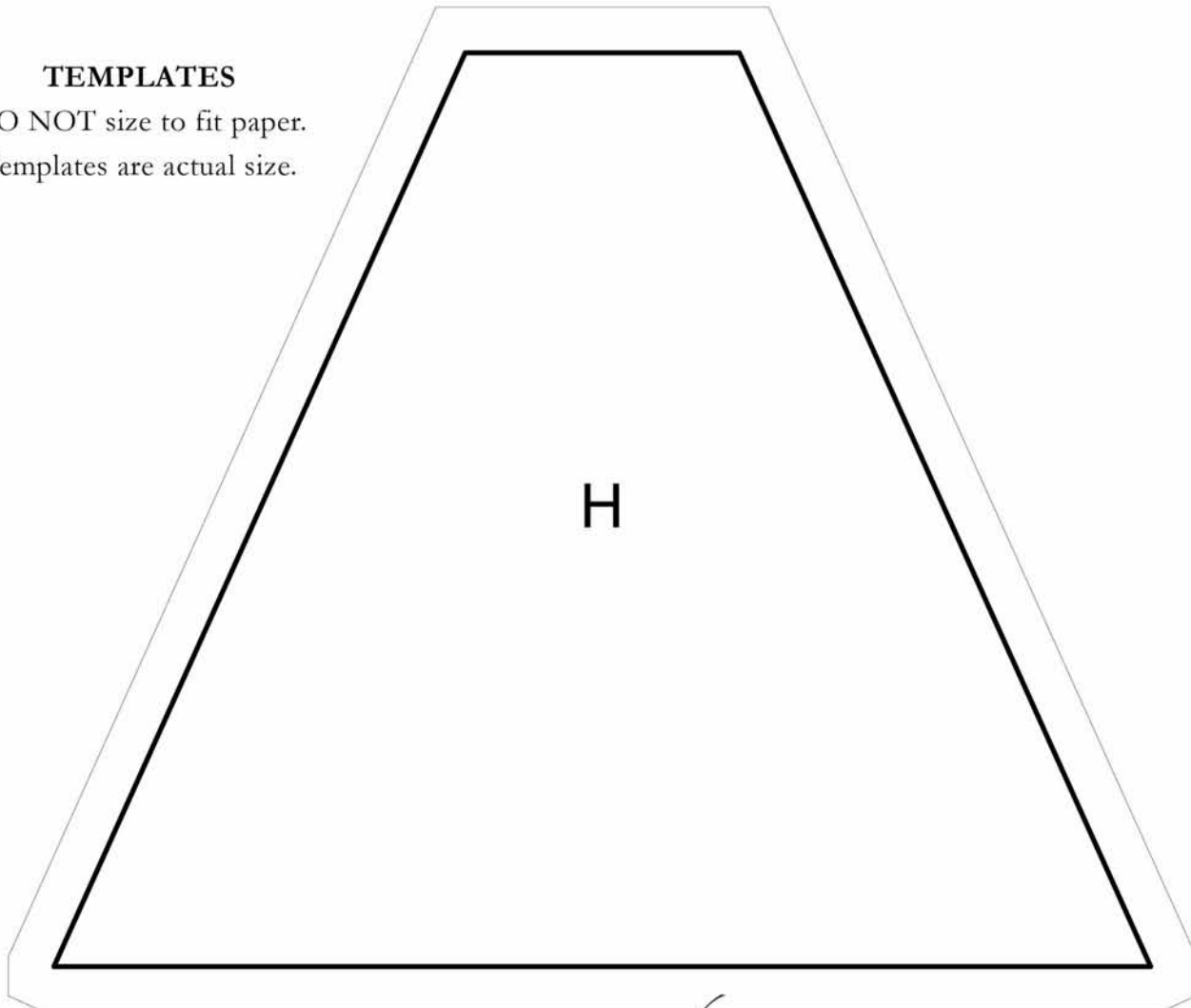

My Mother Sews

Page 7

TEMPLATES

DO NOT size to fit paper.

Templates are actual size.

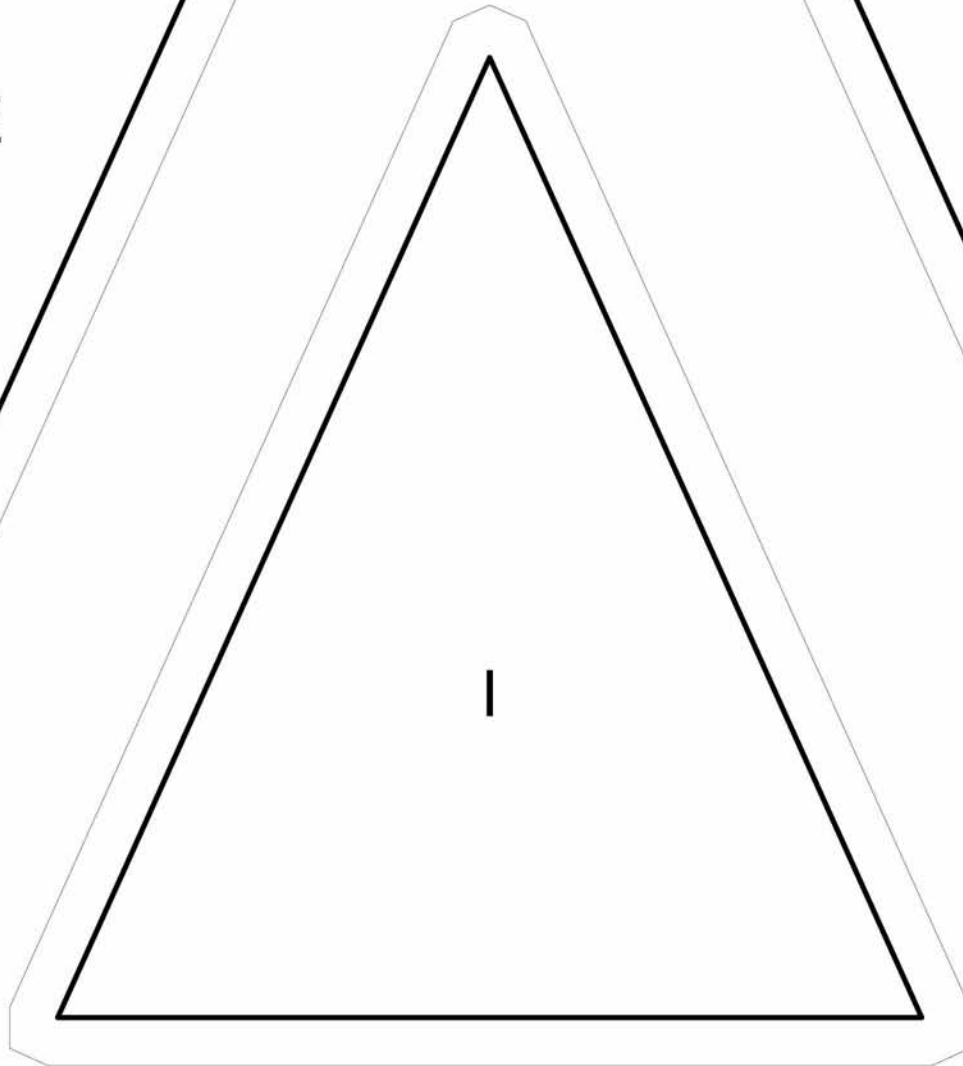
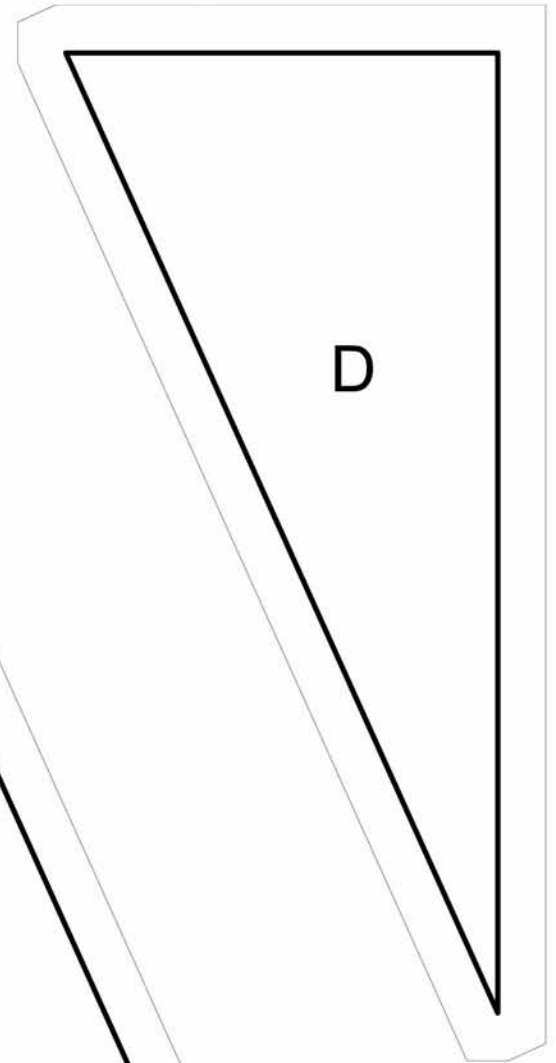
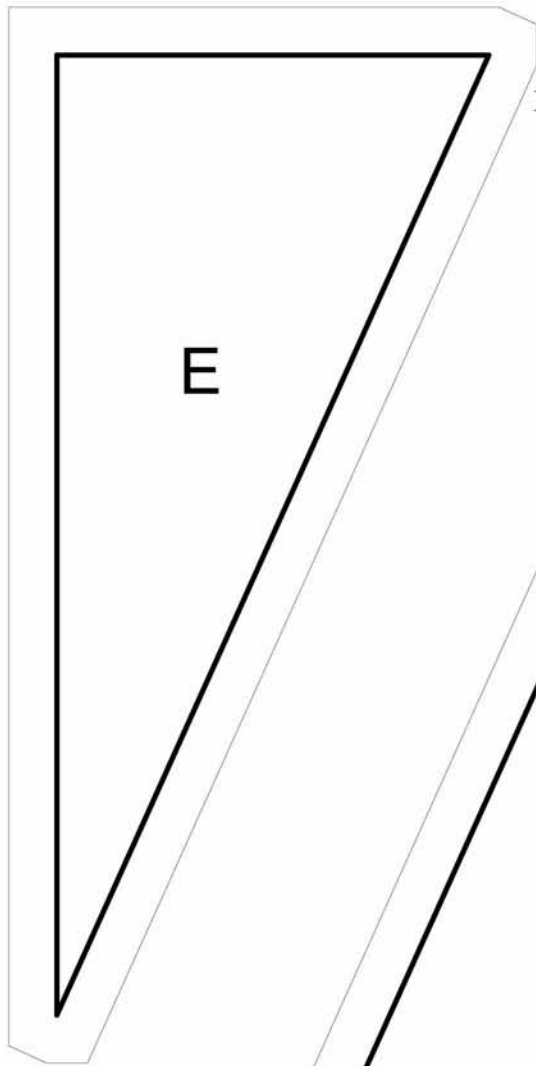

My Mother Sews

Page 8

Buttons

Key Block (3/5 actual size)

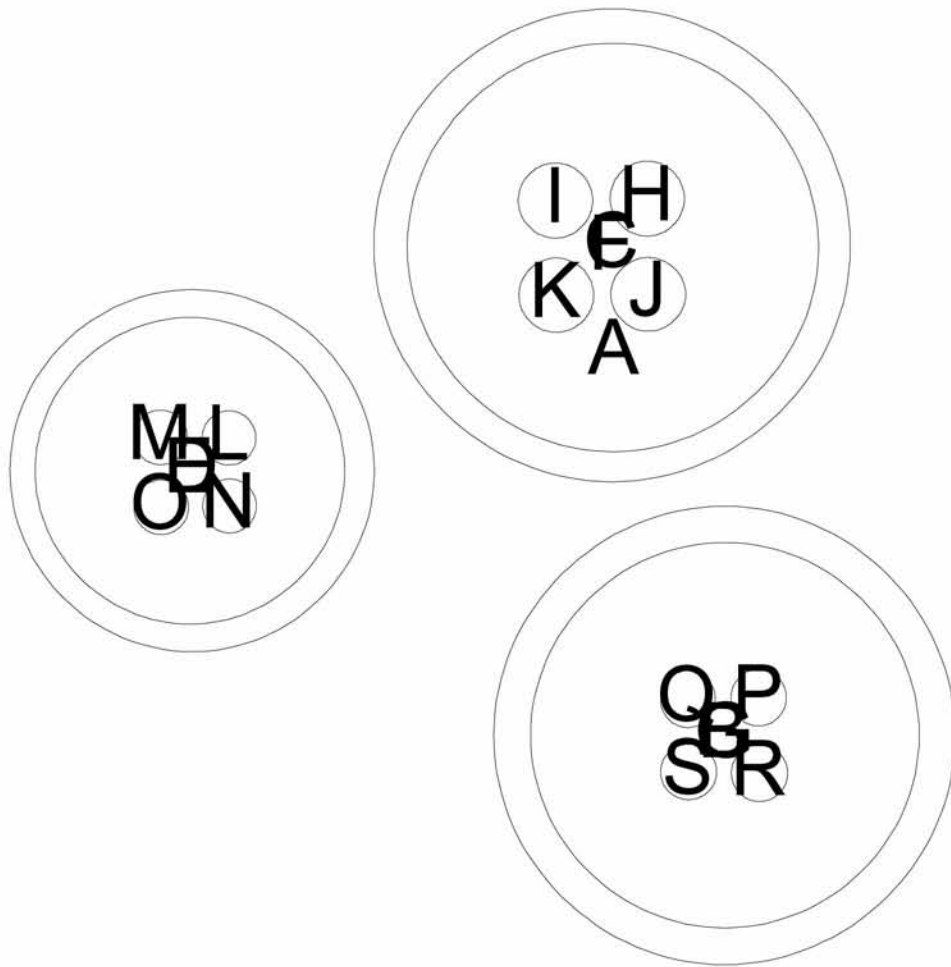

My Mother Sews

Page 9

LARGE BUTTONS

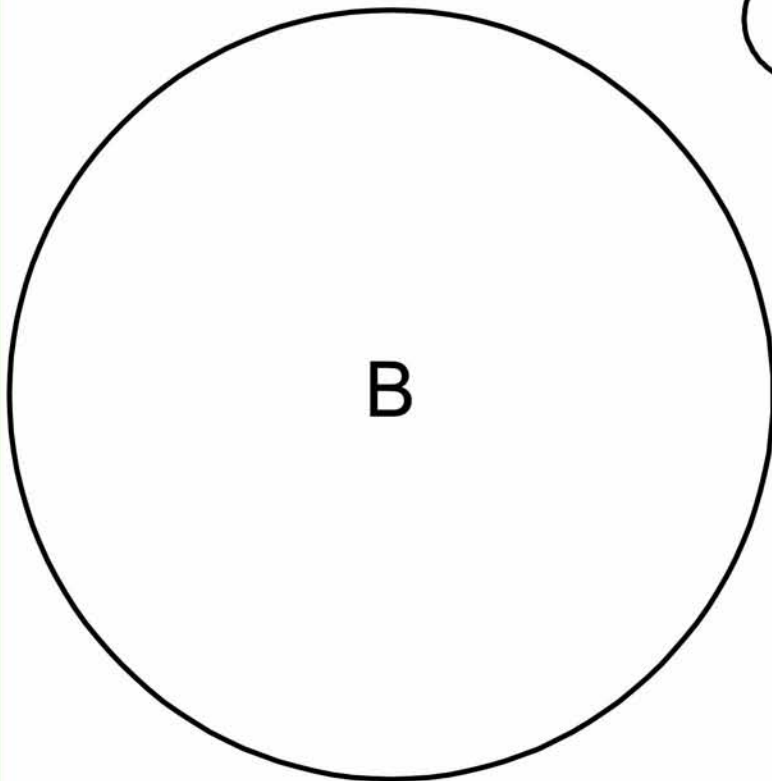
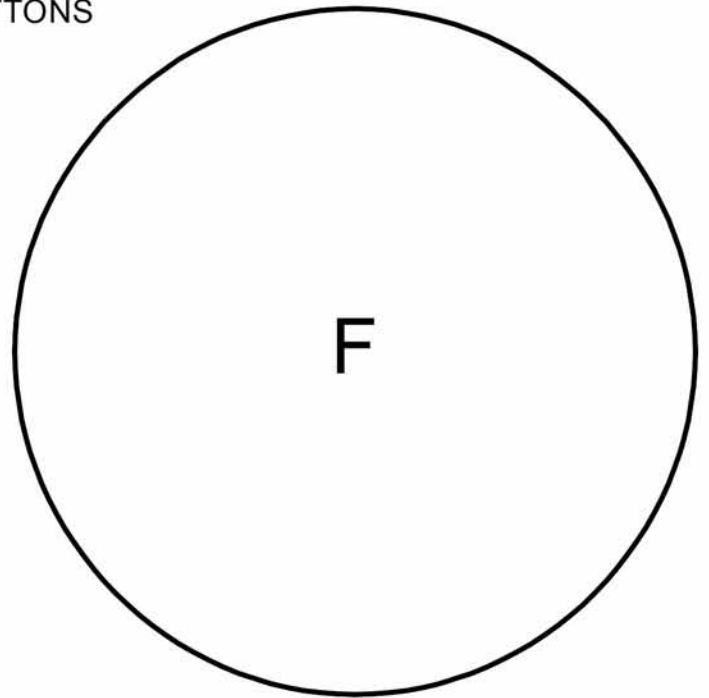
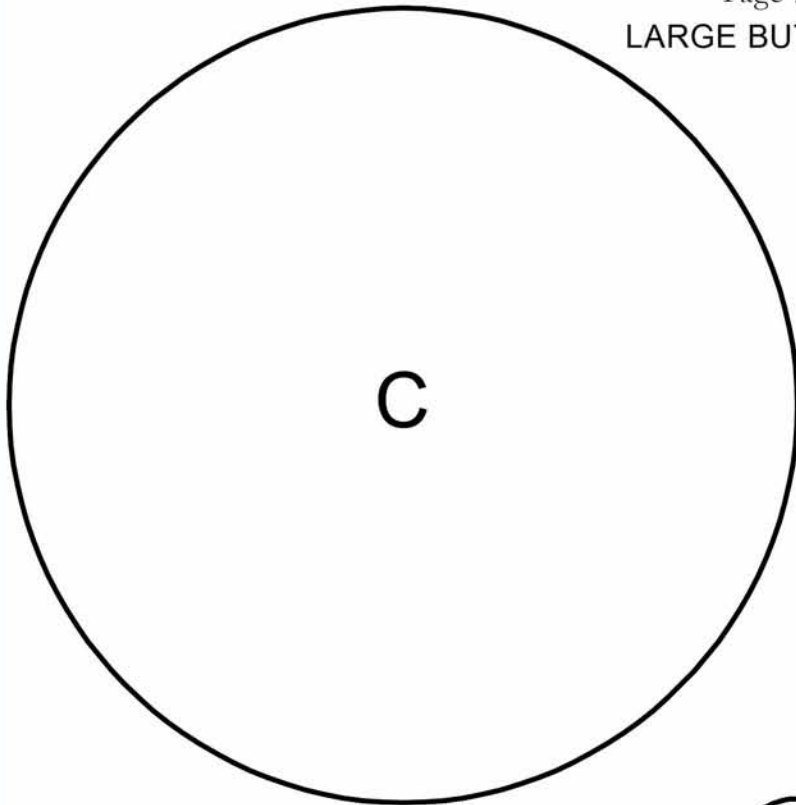

TEMPLATES

DO NOT size to fit paper.

Templates are actual size.

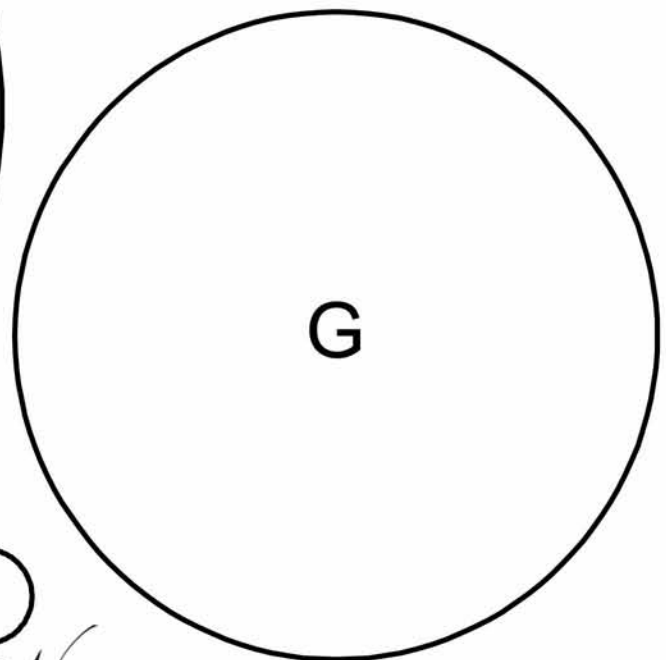

My Mother Sews

Page 10

TEMPLATES

DO NOT size to fit paper.
Templates are actual size.

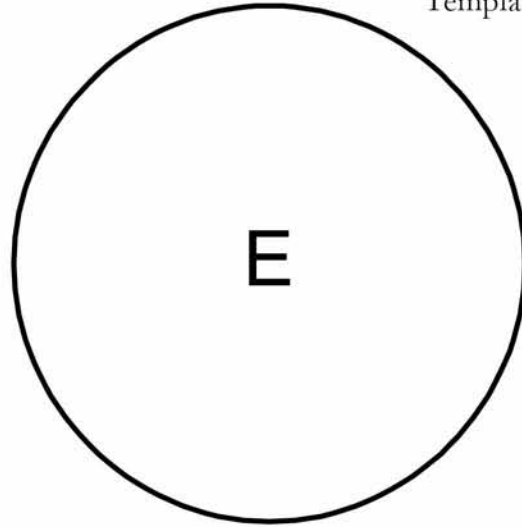
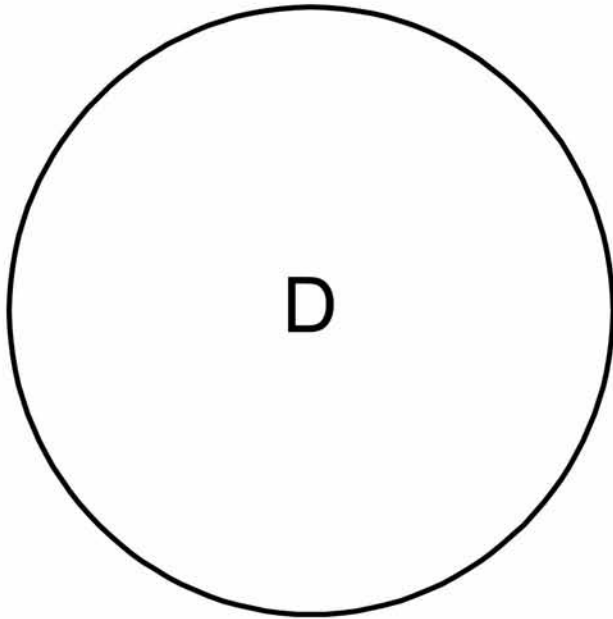

SMALL BUTTONS

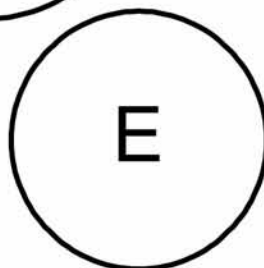
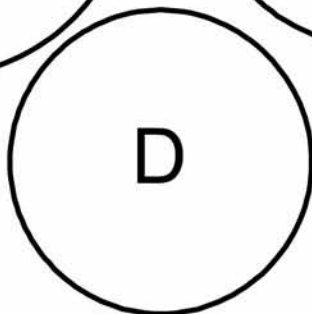
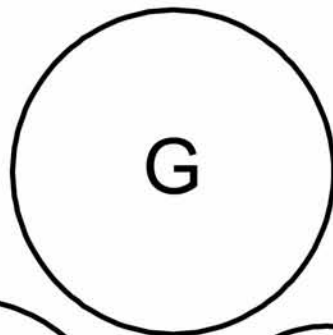
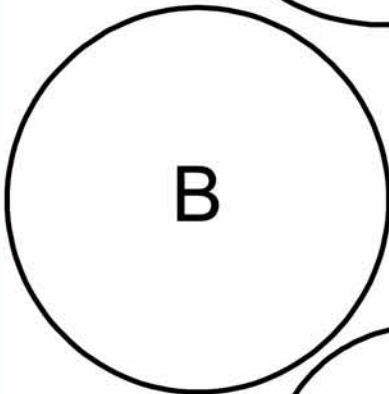
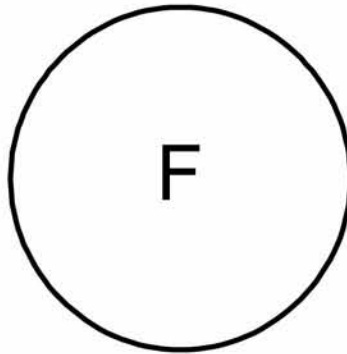
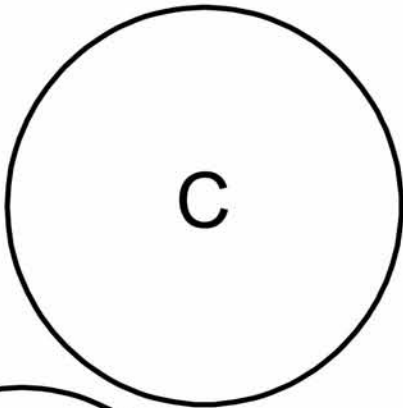

My Mother Sews

Page 11

Scissors

Key Block (31/50 actual size)

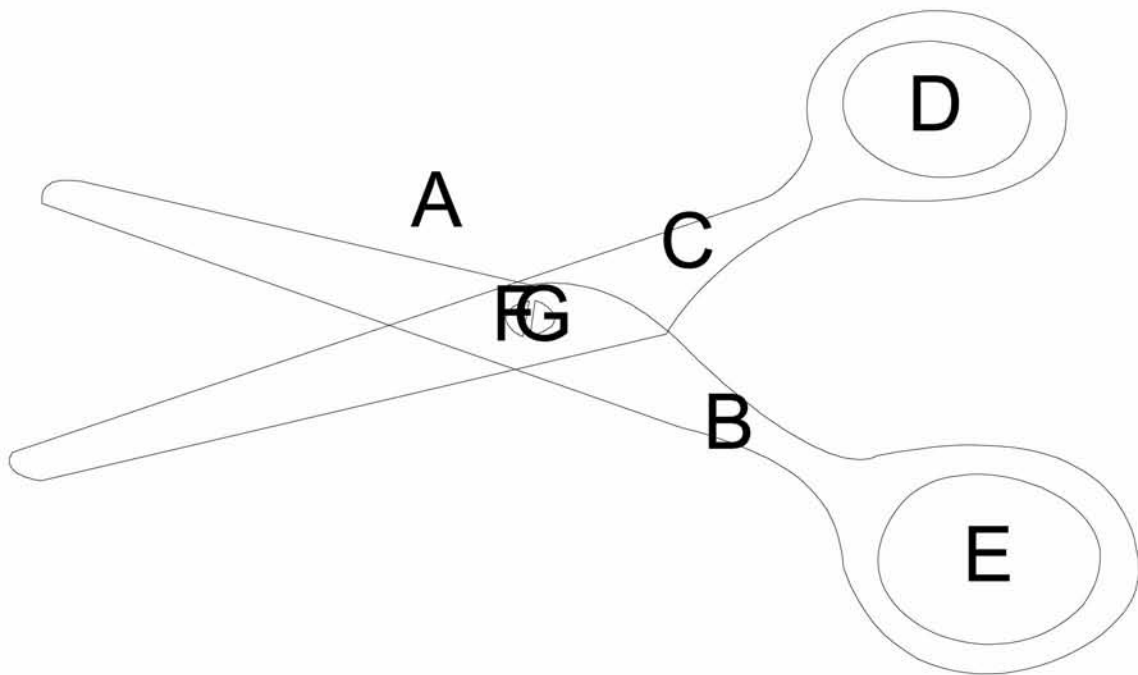

My Mother Sews

Page 12

TEMPLATES
DO NOT size to fit paper.
Templates are actual size.

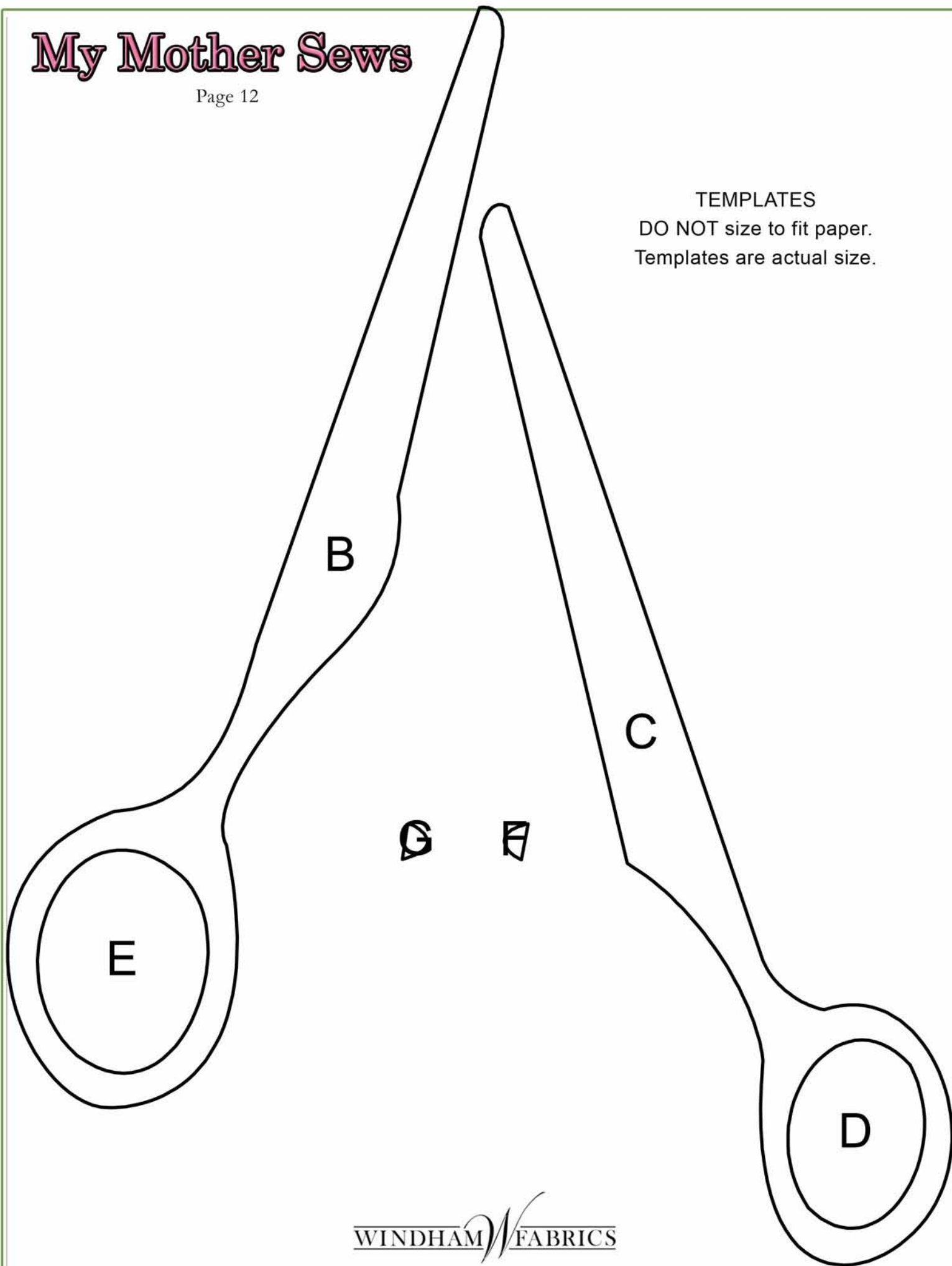

My Mother Sews

Page 13

Sewing Machine

Key Block (31/50 actual size)

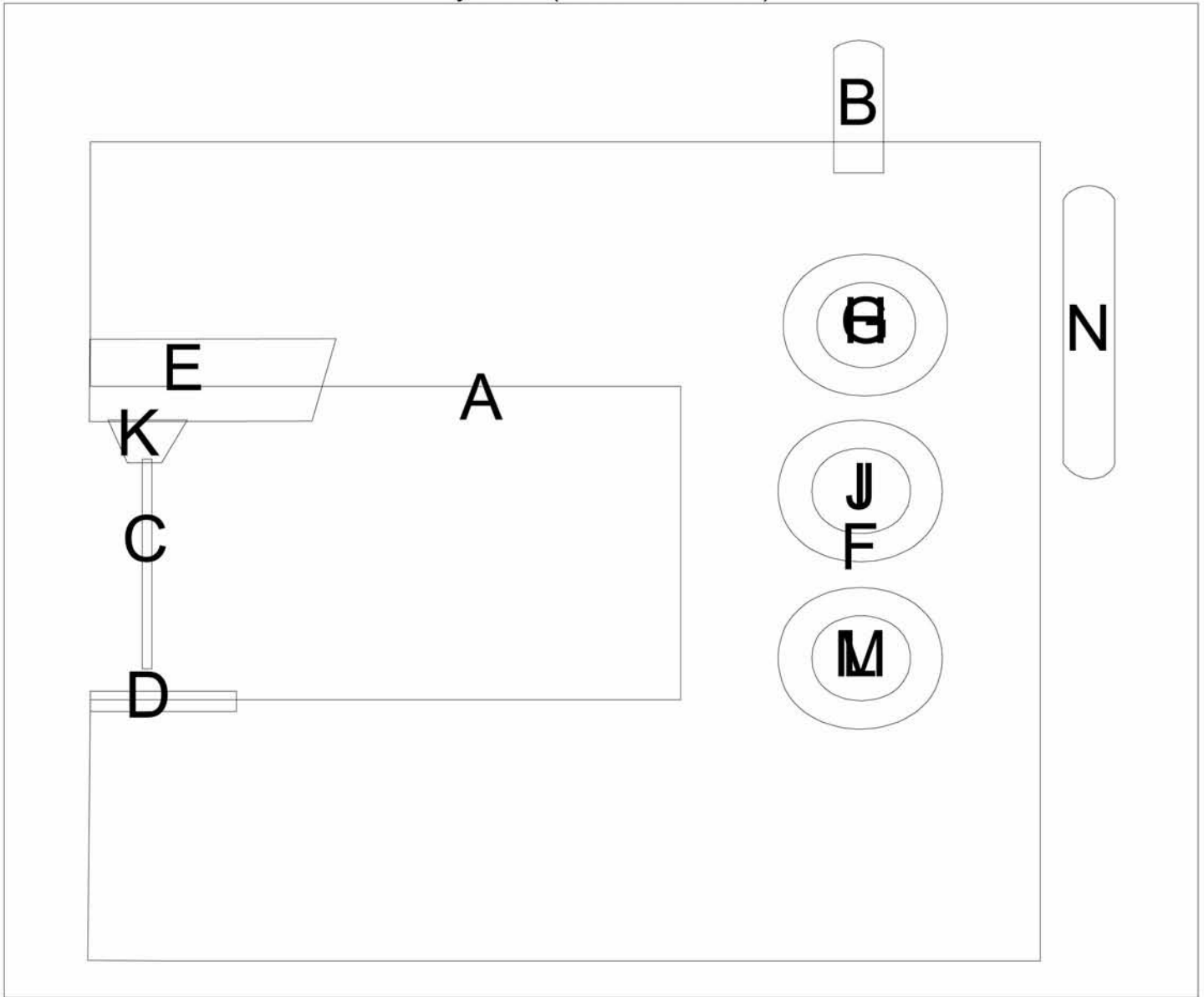

My Mother Sews

Page 14

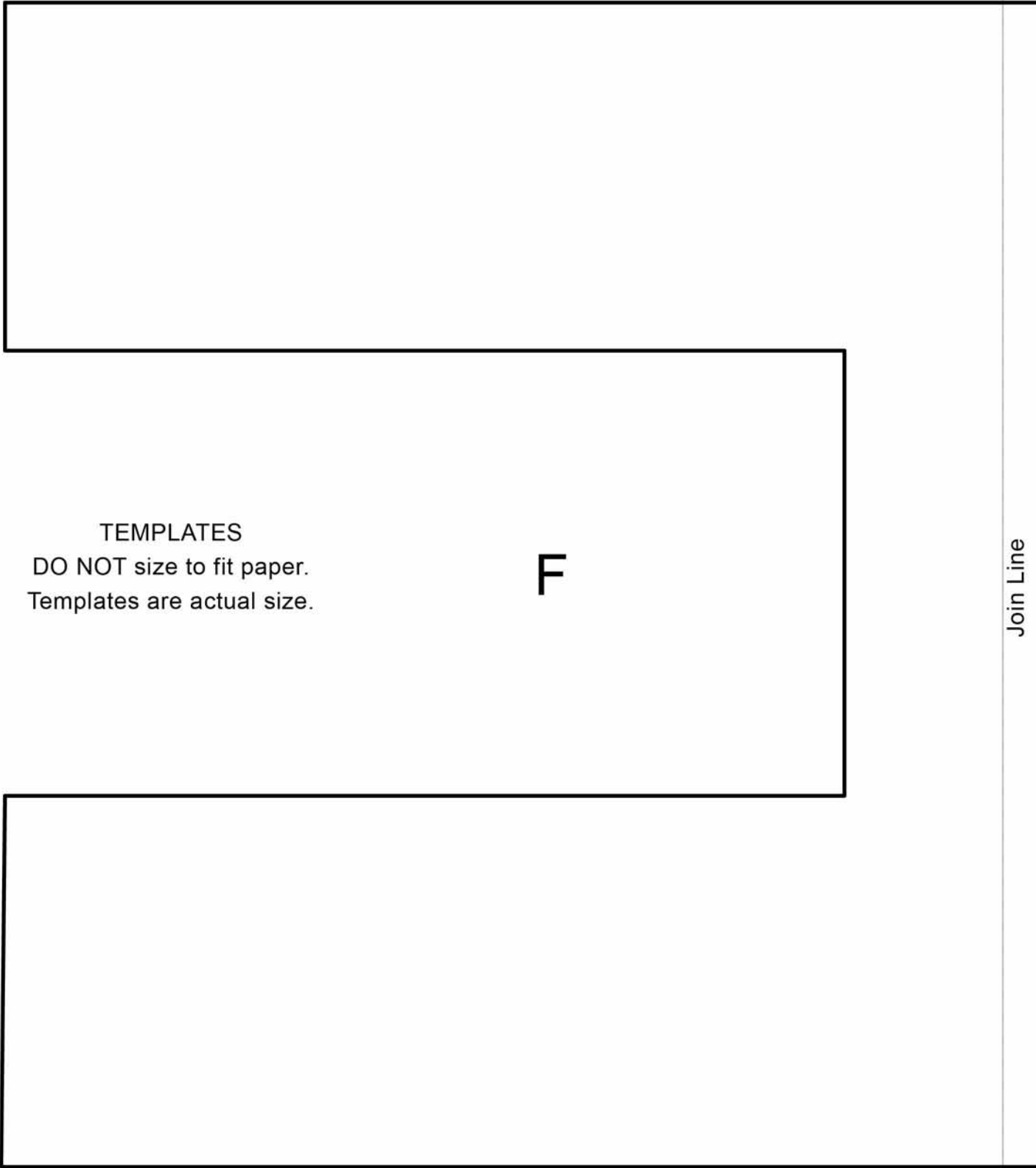

TEMPLATES

DO NOT size to fit paper.
Templates are actual size.

F

Join Line

My Mother Sews

Page 15



TEMPLATES

DO NOT size to fit paper.
Templates are actual size.

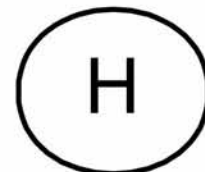
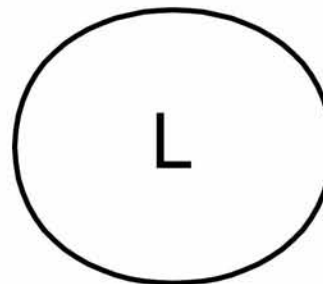
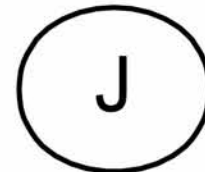
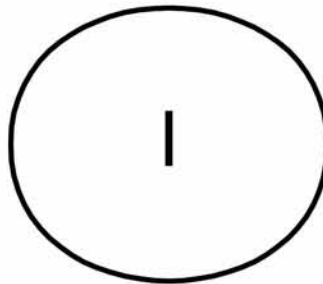
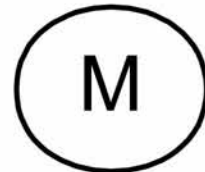
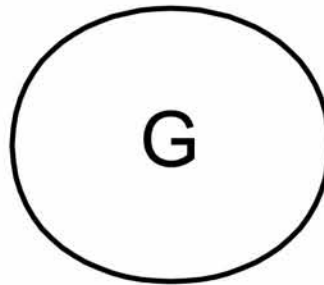

Join Line

My Mother Sews

Page 16

Spools of Thread

Key Block (31/50 actual size)

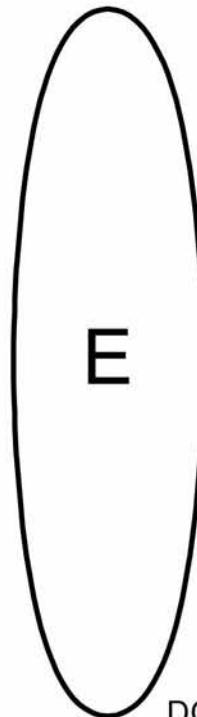
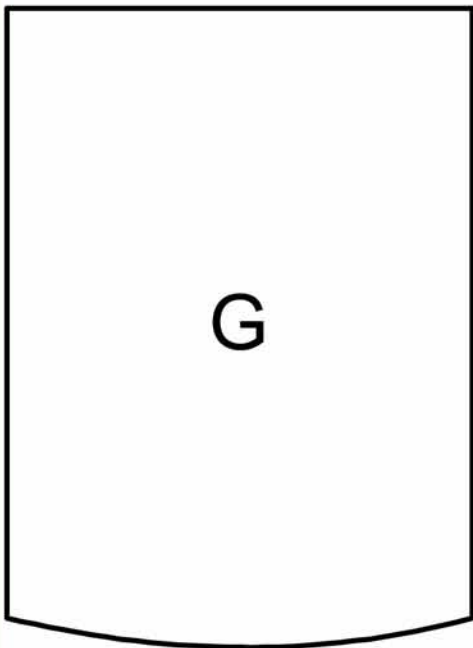
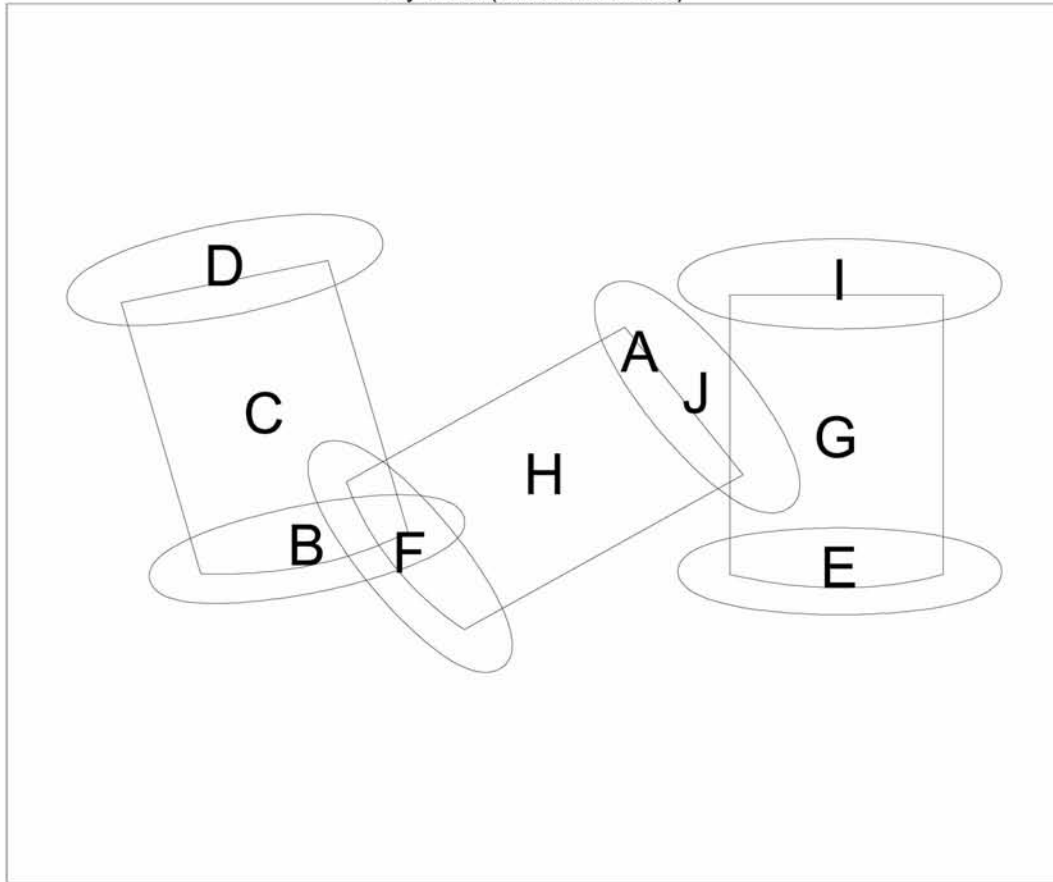

My Mother Sews

Page 17

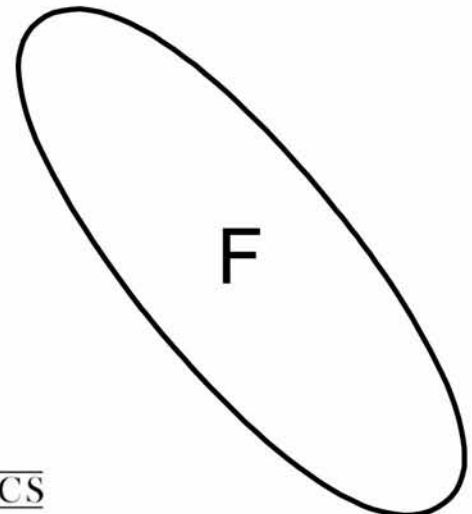
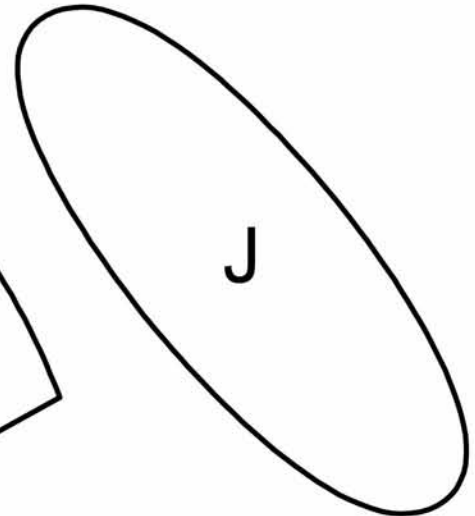
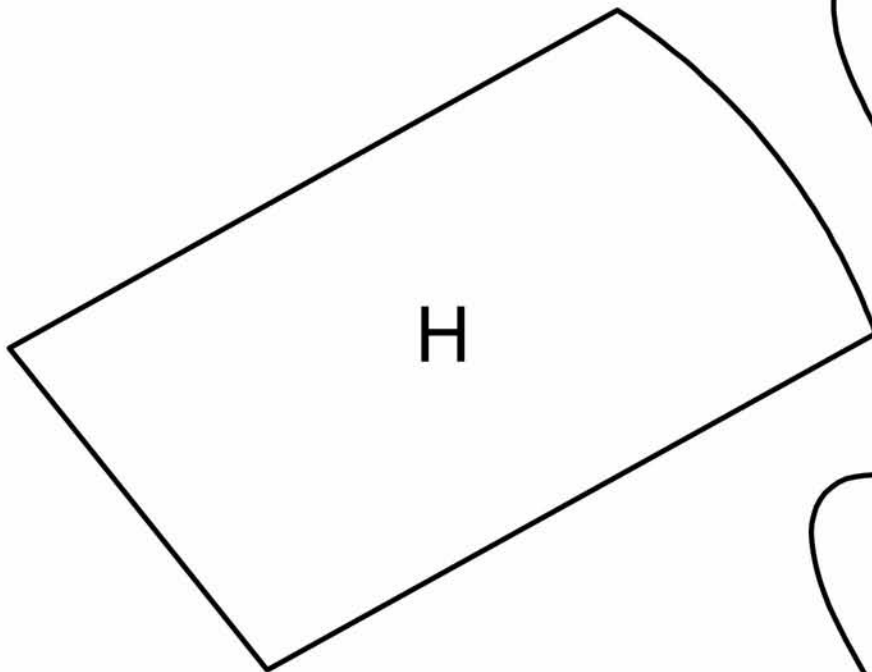
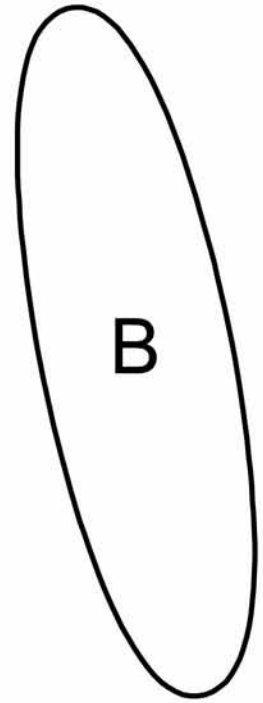
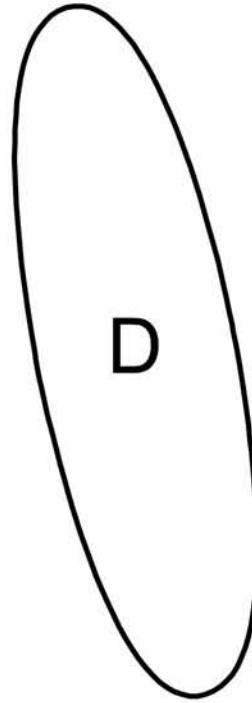
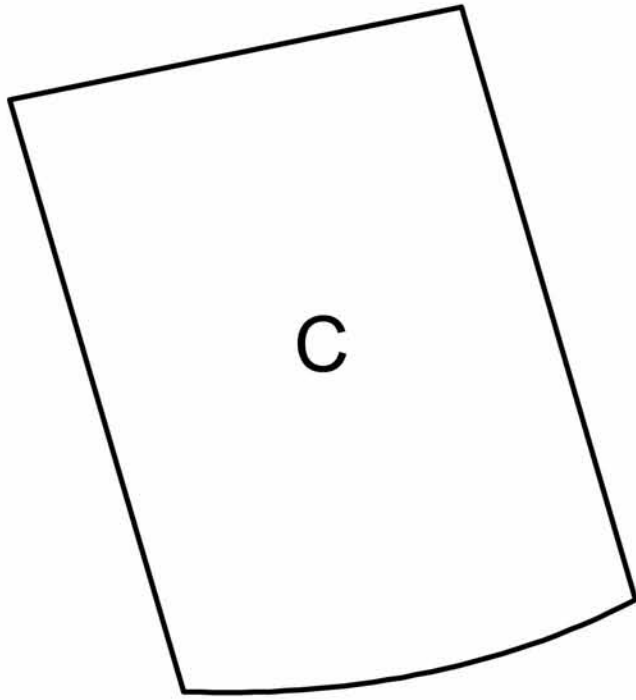

TEMPLATES
DO NOT size to fit paper.
Templates are actual size.