

Midnight Watch

Designed by Diane Nagle
Featuring *Shiloh* by Nancy Gere

SIZE: 70" x 70"

FREE
PROJECT







THIS IS A DIGITAL REPRESENTATION OF THE QUILT TOP, FABRIC MAY VARY.

PLEASE NOTE: BEFORE MAKING YOUR PROJECT, CHECK FOR ANY PATTERN UPDATES AT WINDHAMFABRICS.COM'S FREE PROJECTS SECTION.



Midnight Watch

Cutting Notes: It is very important to mark and store your cutting pieces according to the block they have been assigned to, as this will make it much easier when you start piecing.

KEY	FABRIC	SKU	YD	CUTTING INSTRUCTIONS
A		50495-2 Beige	3/4	QUILT TOP: (3) 3-1/2" x 42" strips. Subcut (24) 3-1/2" x 4" rectangles. (3) 4-3/8" x 42" strips. Subcut (24) 4-3/8" squares, cut once on diagonal.
B		50496-1 Navy	1-3/8	STRIP SET: (5) 2-1/2" x 42" strips. QUILT TOP: (1) 3-1/2" x 42" strips. Subcut (12) 3-1/2" squares. (3) 4-3/8" x 42" strips. Subcut (24) 4-3/8" squares, cut once on diagonal. (3) 3-1/2" x 42" strips Subcut (24) 3-1/2" x 4" rectangles.
C		50498-1 Navy INCLUDES BINDING	2	QUILT TOP: (4) 11" x 42" strips. Subcut into (40) Templates C. BINDING: (8) 2-1/2" x 42" Binding Strips.
D		50498-5 Cream	3	QUILT TOP: (7) 5-1/2" x 42" strips. Sew end to end and Subcut (2) 5-1/2" x 60-1/2" strips and (2) 5-1/2" x 70-1/2" strips. (5) 6" x 42" strips. Subcut (80) Templates A (rotate template for each cut). (5) 6" x 42" strips. Subcut (80) Templates B (rotate template for each cut). (2) 3" x 42" strips. Subcut (16) 3" squares.



Midnight Watch

E		50502-3 Red	3/8	STRIP SET: (4) 2-1/2" x 42" strips.
F		50502-7 Blue	5/8	STRIP SET: (8) 2-1/2" x 42" strips.
G		50503-3 Red	1/2	STRIP SET: (6) 2-1/2" x 42" strips.
H		50504-3 Red	1/4	STRIP SET: (2) 2-1/2" x 42" strips.
		Backing	4-1/2	74" x 74" piece of batting.

Block Assembly

Checkerboard Block - *It is very important to mark your sets of segments after they have been cut from each strip set.*

1. This block will be sewn together in 5 horizontal rows cut from strip sets made for each row. Choose a 2-1/2" strip of the following fabrics: **B, F, G, E,** and **H**. Sew them together in that order from top to bottom along the long sides to make a strip set. See *Figure 1*. Square up the left end of the strip set and cut a 2-1/2" segment vertically, perpendicular to the seams. Repeat to cut a total of (13) segments for Row 1 of the block. Mark the segments as Row 1 and set aside →

Row 1 Strip Set
Cut 13 Segments at 2-1/2"



Figure 1. (Fabric B is at the top and Fabric H is at the bottom).



Midnight Watch

2. Repeat this same process for Row 2, sewing the 2-1/2" x 42" strips in the following order from top to bottom using fabrics: **F, B, F, G** and **E**. Again, cut (13) segments from the strip set and set aside. Mark the segments as Row 2. Continue in this manner as follows for the remaining 3 rows: (each row has its own strip set).

(USE THE QUILT DIAGRAM ON PAGE 6 AS A REFERENCE).

(Row 3): **G/F/B/F/G**

(Row 4): **E/G/F/B/F**

(Row 5): **H/E/G/F/B**

3. Rotate a Row 1 segment so the **Fabric B** is on the left. One at a time, add a segment from rows 2-5 under Row 1. Check for the correct rotation of each segment. See *Figure 2*. Once they all line up correctly (you will see a pattern forming), sew each row together horizontally from top to bottom to complete the block. Make (13). Square up to 10-1/2".

FIGURE 2

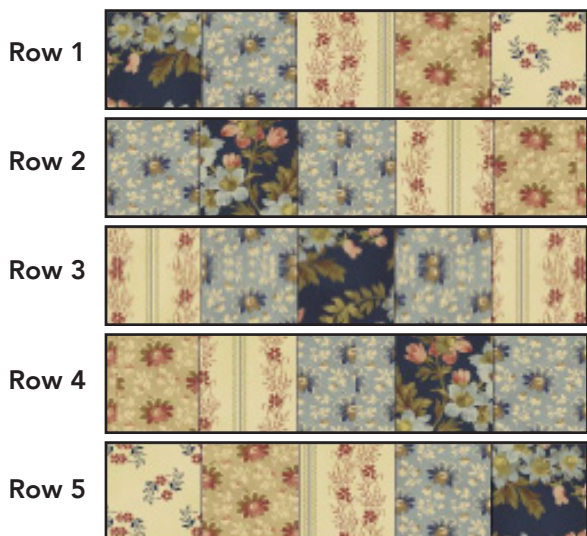

CHECKERBOARD BLOCK



4. Spool Block. Sew the 3-1/2" side of a **Fabric A** 3-1/2" x 4" rectangle to both sides of a **Fabric B** 3-1/2" square as shown. Square up to 10-1/2" x 3-1/2".

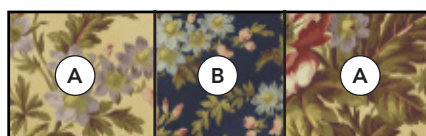



Midnight Watch

5. Sew **Fabric A** and **B** 4-3/8" triangles together on long sides to make a Half Square Triangle (HST). Square to 4".



6. Sew a HST to both 4" sides of a **Fabric B** 3-1/2" x 4" rectangle as shown. Make (2).

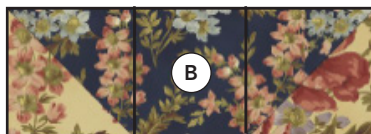

7. Sew a unit from Step 6 to the top of the unit in Step 4. Rotate the remaining unit from Step 6 and sew to the bottom of the block to complete. Square up to 10-1/2". Make (12).

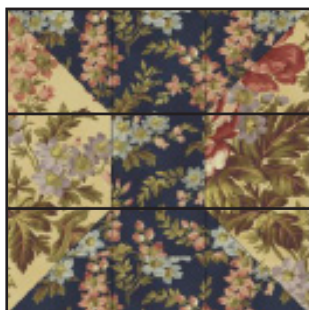

Sashing Unit

1. Sew a **Fabric D** Template A to both opposite corners of a **Fabric C** Template C.
2. Sew a **Fabric D** Template B to both remaining opposite sides of Template C to complete a Sashing Unit as shown. Square up to 10-1/2" x 3". Make (40).





Midnight Watch

Quilt Assembly

1. The quilt center is made of 5 horizontal rows of 5 blocks each with sashing and cornerstone rows in between the blocks. Following diagram for placement and rotation of each block, sew each row in the order stated from left to right.

2. Row 1: Sew (3) Checkerboard Blocks with the diagonal color pattern going from left to right as shown, alternating with (2) horizontally rotated Spool Blocks and a Sashing Unit between each block. Make (3) rows.

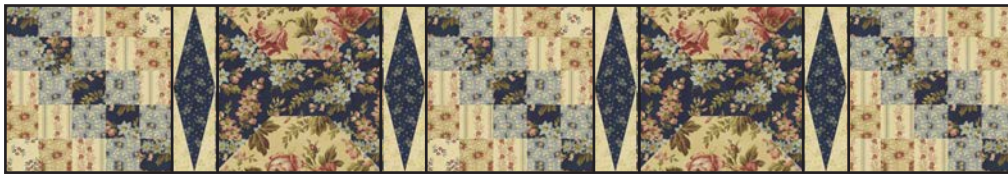

3. Row 2: Sew (3) Spool Blocks with the spool in a vertical rotation, alternating with (2) Checkerboard blocks with the diagonal color pattern going from right to left as shown, and a Sashing Unit between each block. Make (2) rows.

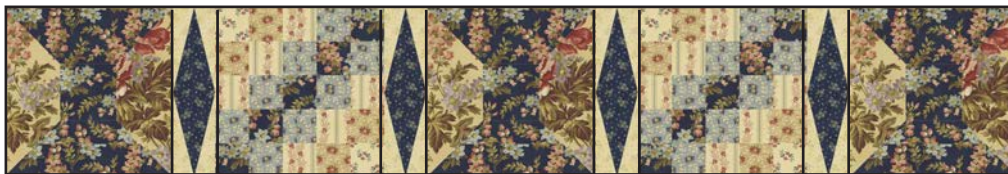

4. Sew (5) Sashing Units end to end in a horizontal row with **Fabric D** 3" squares in between each one. Make (4).



5. Sew the horizontal rows together as follows from top to bottom to complete the quilt center: Row 1, Sashing Row, Row 2, Sashing Row, Row 1, Sashing Row, Row 2, Sashing Row, and the last row is the remaining Row 1 sewn to the bottom of the quilt.

6. Outer Border. Sew the **Fabric D** (2) 5-1/2" x 60-1/2" strips to the sides of quilt center. Sew the **Fabric D** (2) 5-1/2" x 70-1/2" strips to the top and bottom of quilt.





Midnight Watch

Quilt Diagram

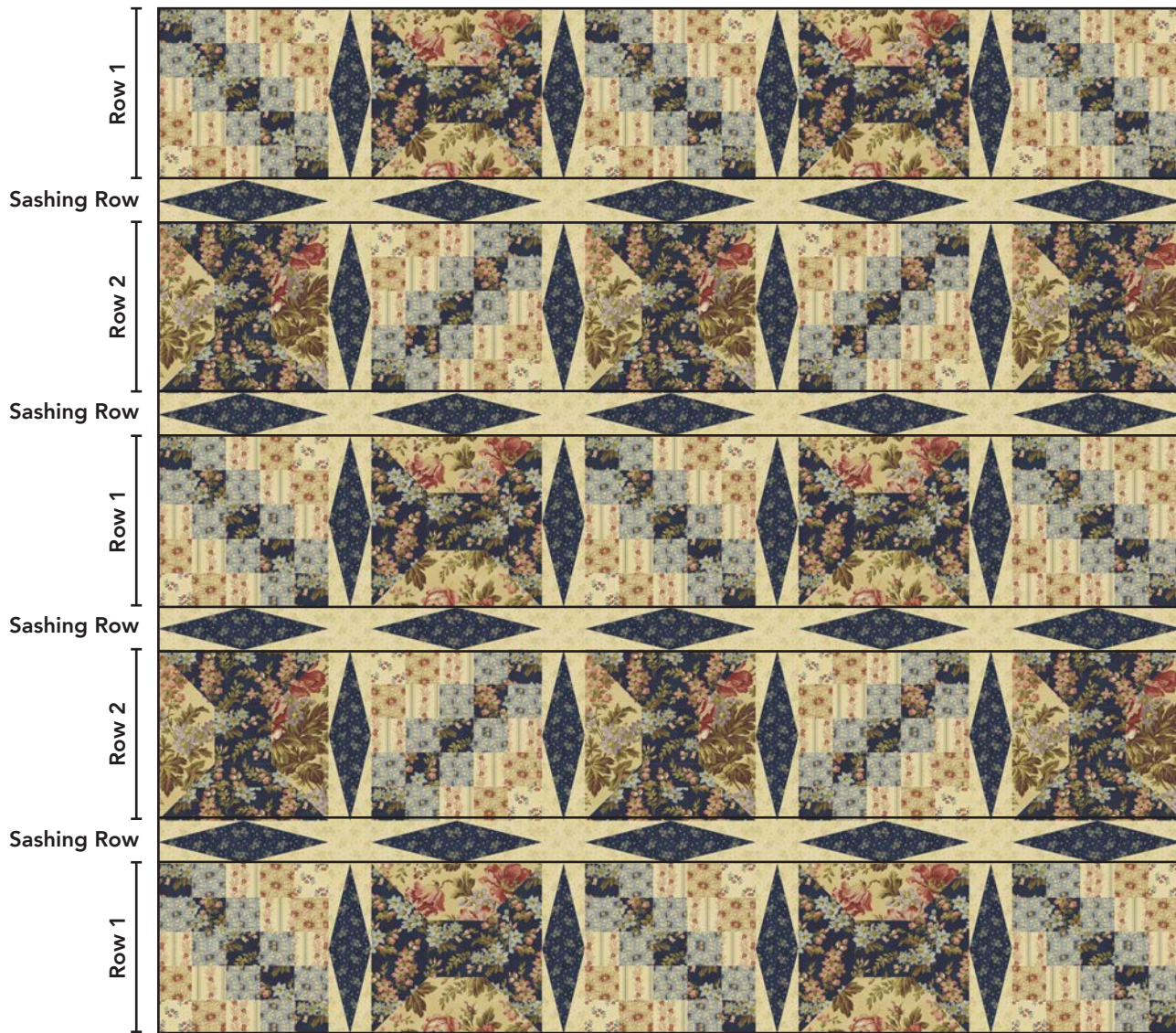



Midnight Watch

Finishing

1. Layer quilt top, batting and backing together.
2. Baste and quilt as desired.
3. Attach **C** binding to complete quilt.





Templates - Midnight Watch

PLEASE PRINT TEMPLATES AT 100%

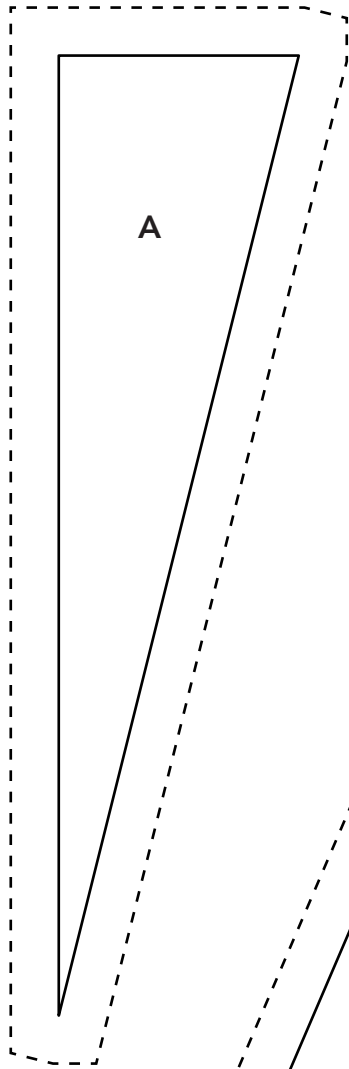
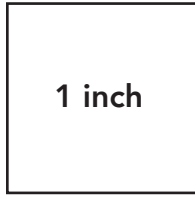

A

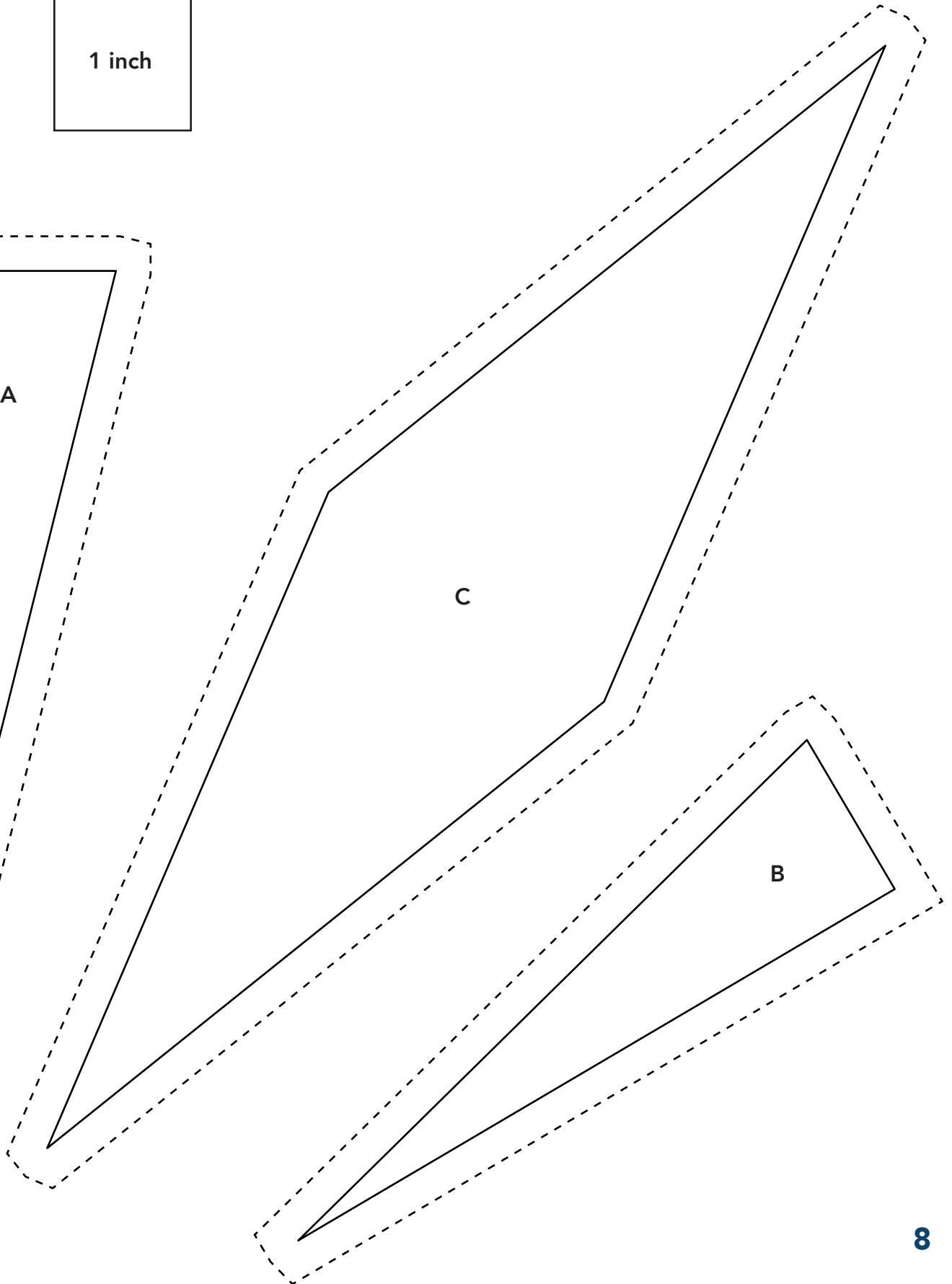

C

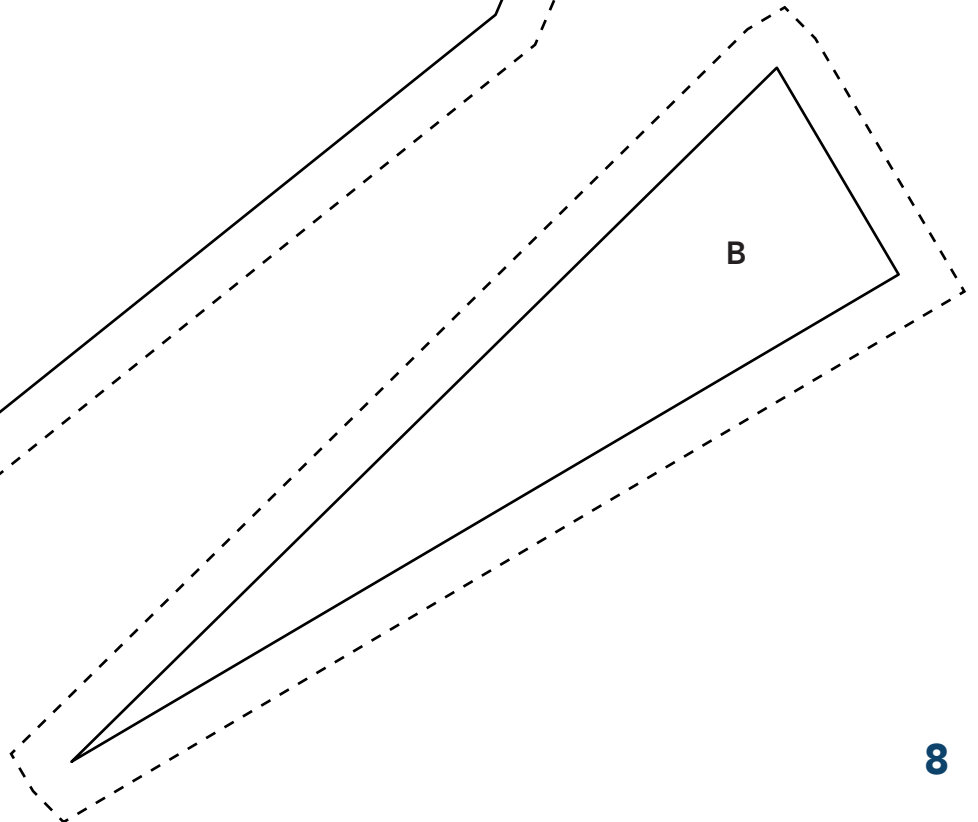

B