

# Fashion Market Tote

Designed by Whistler Studios

Featuring the Farm Stand Collection by Whistler Studios

Size: 18" x 18"



Check [www.windhamfabrics.com](http://www.windhamfabrics.com) Free Project section to see if there are any pattern updates before you start your quilt project

**WINDHAM FABRICS**

812 Jersey Ave ~ Jersey City, NJ 07310 ~ 201.659.0444 ~ FAX: 201.659.9719  
[www.windhamfabrics.com](http://www.windhamfabrics.com) email: [retail@windhamfabrics.com](mailto:retail@windhamfabrics.com)

# Fashion Market Tote

Designed by Whistler Studios  
Featuring the Farm Stand Collection by Whistler Studios  
Size: 18" x 18"



38911-X



38912-X

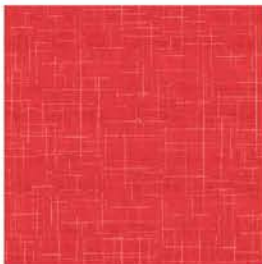

38913-1

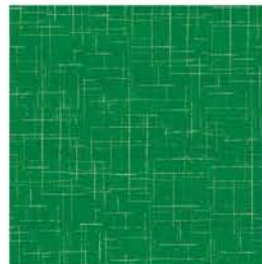

38913-3



38914-X

## Fabric Requirements:

- 1/2 yard 38911-X Multi Seed Packets
- 1/3 yard 38912-X Multi Veggie Print
- 1/2 yard 38913-1 Red Texture
- 1-1/8 yards 38913-3 Green Texture (for lining)
- 1/2 yard 38914-X Multi Word Print

## Cutting Instructions:

- 38911-X Multi Seed Packets  
Cut (2) 12-1/2" x 14" for pockets
- 38912-X Multi Veggie Print  
Cut (2) 21-1/4" x 5-5/8" for top section  
Cut (2) Triangle insets Template A
- 38913-1 Red Texture  
Cut (2) 12-1/2" x 1-3/4" for pocket top  
Cut (2) 21-1/4" x 1-3/4" for tote insert  
Cut (4) 24" x 2" for handles
- 38913-3 Green Texture  
Cut (2) 21-1/4" x 21"  
Cut (2) Triangle insets Template A  
Cut (2) 12-1/2" x 15-1/4"
- 38914-X Word Print  
Cut (2) 21-1/4" x 14"

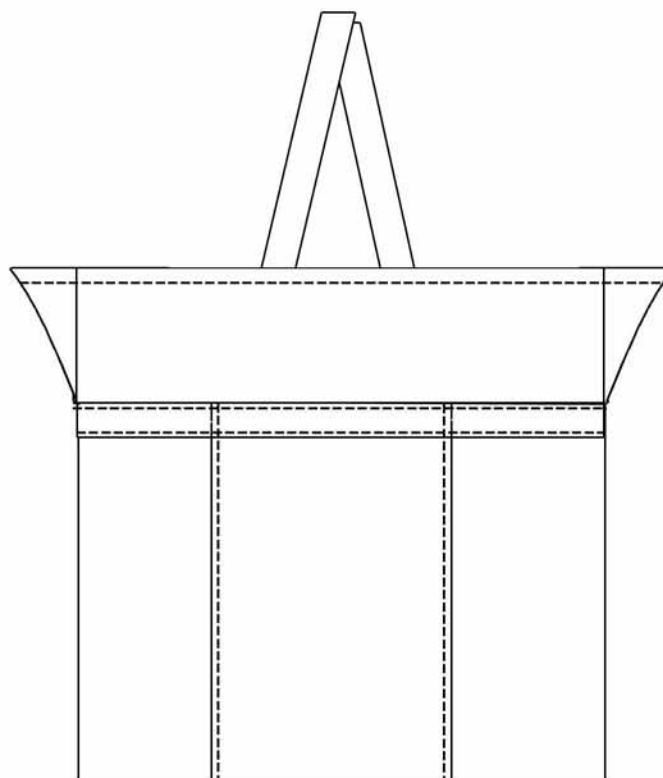

Diagram 1

1 yard Fusible Batting



# Fashion Market Tote

Page 2

## Assembly:

### Outside of Tote

1. Take one piece of word print and join one red texture strip to the top.
2. Take the veggie print and attach to the top of the red texture strip. Diagram 2
3. Add the fusible batting to the wrong side following the manufacturer's recommended instructions. Trim to fit. Repeat for the other side.
4. Take the two veggie print triangle pieces and add the fusible batting to the wrong side. Set aside.
5. Take one pocket piece and join the red texture strip to the top. With right sides together, add green texture pocket lining and sew around all sides but the bottom. Clip seam allowance from corners, turn and press. Edge topstitch on each side of the red texture strip.
4. Take the pocket and place 4-1/2" from edge and line up the top red texture strip with the strip on the tote. Edge stitch the pocket in place on each side. Diagram 3
5. Repeat the above steps for the other side.
6. Take one side of the tote and add the a triangle veggie piece to each side at the top. Diagram 3
7. With right sides together, join the 2 sides of the tote. At the bottom of the top veggie print where the triangle piece comes to a point, clip the seam allowance on the tote side of the point so that you will be able to sew the side seam easily at the top.

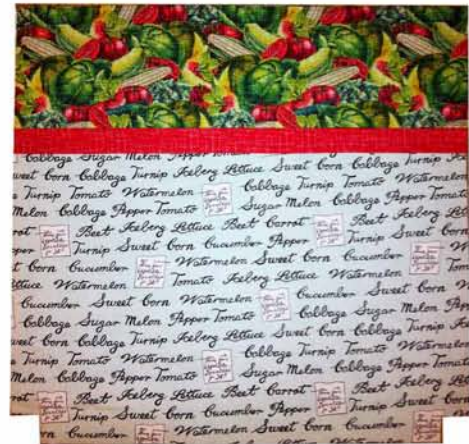
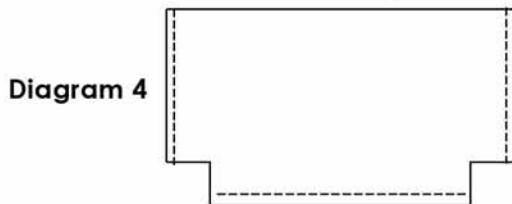

Diagram 2

8. Join the bottom seam. Diagram 4



9. Take the bottom cutout section and with seam allowances together, pinch the the open sections of the bottom corner squares together and stitch closed. Diagram 5

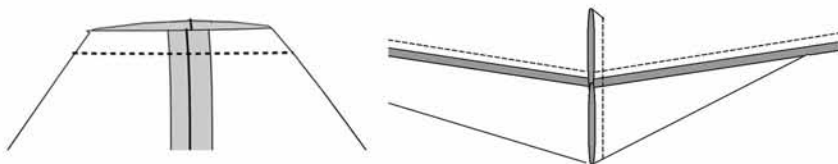

Diagram 5



Diagram 3

# Fashion Market Tote

Page 3

## Handles

1. Take one handle piece and add the fusible lining to the wrong side.
2. With the right sides together, stitch the long sides, turn and press flat. Add a 1/4" topstitch to each side.
3. Repeat for the other handle.
4. Take one side of the tote and one handle and place the handle at the top edge 2 1/2" from the center.
5. Repeat for the other side. Diagram 6

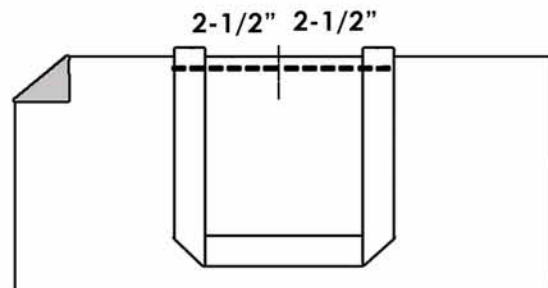

Diagram 6

## Lining

1. With wrong sides together, take one side of lining and one triangle and machine stitch triangle to top side edge. Repeat for the other side.
2. Join the side seams together, leaving a 4-5" opening on one side to turn the tote later.
3. Join the the bottom and side corners as instructed for the outside of the tote.

## Final Assembly:

1. With right sides together, slide the lining over the tote and match the top edge. Stitch the top opening closed being careful that handles are flat to the tote and don't get caught in the top seam.
2. Turn the tote to the right side by pulling it through the lining opening. Machine edge stitch the lining opening closed.
3. Press the top edge rolling the seam allowance slightly to the inside so that you do not see the lining at the top.
4. Add a 3/8" topstitch to hold the lining in place.
5. Tack the lining in a few places at the bottom to keep lining from coming out of the tote.

**ENJOY!**

Be sure to visit [www.windhamfabrics.com](http://www.windhamfabrics.com) to see the complete collection and to download other Free Projects

# Fashion Market Tote

Page 4

TRIANGLE TEMPLATE A  
actual size

