

BEGINNER
SKILL

Technicolor Tiles

designed by Natalie Crabtree

featuring *Paradiso* by Sally Kelly, *Palette* by Marica Derse,
and *Ruby and Bee Solids* by Heather Ross and Annabel Wrigley

SIZE: 74" x 74"

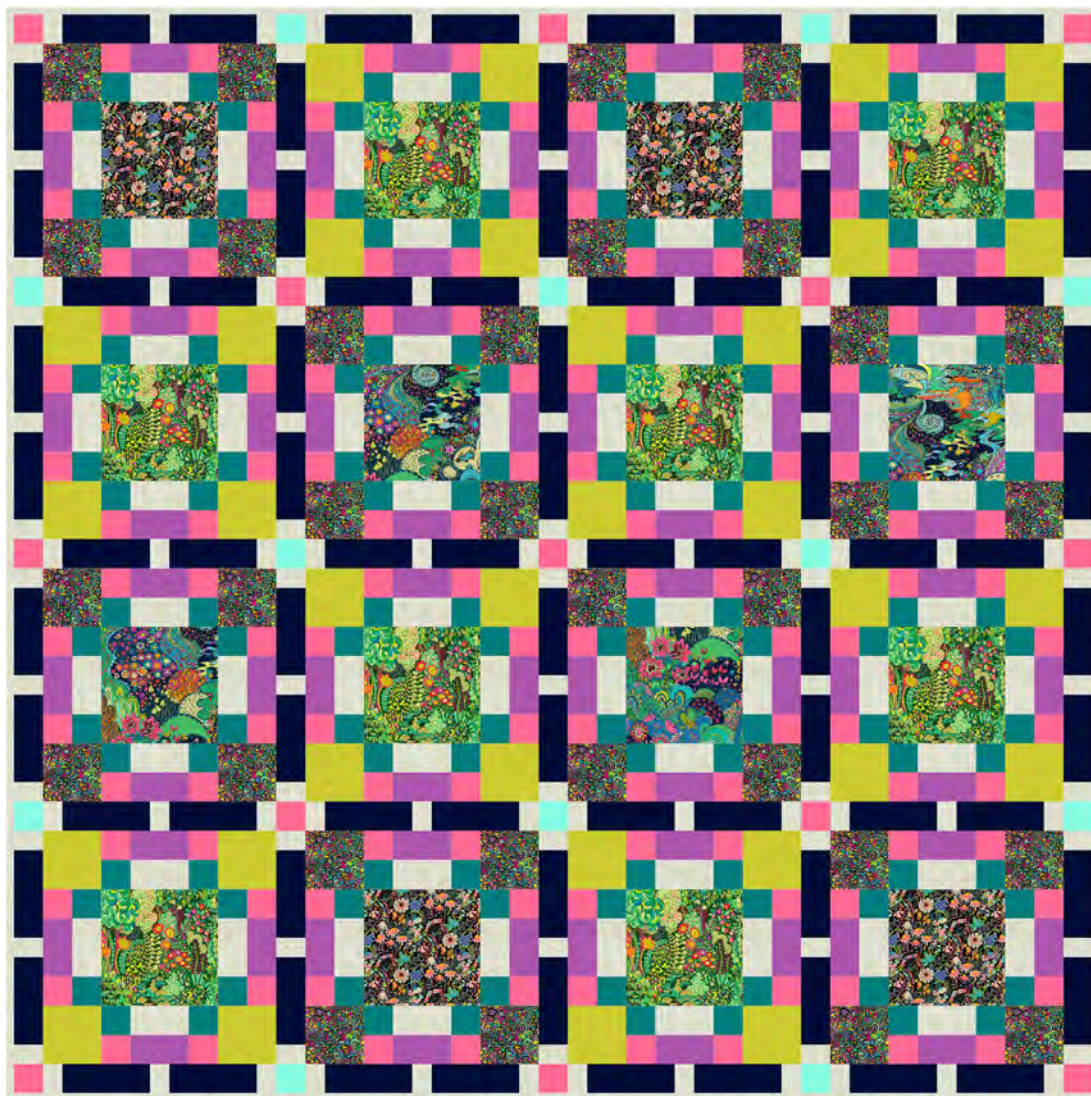









FREE
PROJECT

THIS IS A DIGITAL REPRESENTATION OF THE QUILT TOP, FABRIC MAY VARY.

PLEASE NOTE: BEFORE MAKING YOUR PROJECT, CHECK FOR ANY PATTERN UPDATES AT WINDHAMFABRICS.COM FREE PROJECTS SECTION.



Technicolor Tiles

KEY	FABRIC	SKU	YD	CUTTING INSTRUCTIONS
A		PALETTE 37098-56 Cloud INCLUDES BINDING	1 ¾	(9) 2" x WOF strips for Sashing Assembly. (4) 4 ½" x WOF strips for Strip Set A. FOR BINDING: (8) 2 ¼" x WOF strips for binding.
B		PARADISO 51932D-2 Black	¾	(1) 8 ½" x WOF strip. Subcut (4) 8 ½" squares for blocks.
C		PARADISO 52647D-1 Midnight	¾	(1) 8 ½" x WOF strip. Subcut (4) 8 ½" squares for blocks.
D		PARADISO 52648D-3 Green	⅝	(2) 8 ½" x WOF strips. Subcut (8) 8 ½" squares for blocks.
E		PARADISO 52649D-2 Black	⅝	(4) 4 ½" x WOF strips. Subcut (32) 4 ½" squares for blocks.
F		RUBY+BEE SOLIDS 51583-7 Perfect Pink	⅞	(1) 2 ½" x WOF strip. Subcut (13) 2 ½" squares for cornerstones. (8) 2 ½" x WOF strips for Strip Set B.
G		RUBY+BEE SOLIDS 51583-13 Salvia	⅝	(4) 4 ½" x WOF strips for Strip Set B.
H		RUBY+BEE SOLIDS 51583-14 Night Sky	1 ⅛	(6) 6 ¼" x WOF strips for Sashing Assembly.
I		RUBY+BEE SOLIDS 51583-19 China Blue	¾	(8) 2 ½" x WOF strips for Strip Set A.
J		RUBY+BEE SOLIDS 51583-20 Starling	⅛	(1) 2 ½" x WOF strip. Subcut (12) 2 ½" squares for cornerstones.
K		RUBY+BEE SOLIDS 51583-27 Avocado	⅝	(4) 4 ½" x WOF strips. Subcut (32) 4 ½" squares for blocks.
		Backing	4 ½	Batting 82" x 82"

WOF=WIDTH OF FABRIC

PROJECT DISCLAIMER: Every effort has been made to ensure that all projects are error free. All the information is presented in good faith, however, no warranty can be given nor results guaranteed. Therefore, we assume no responsibility nor damages that may occur when referring to this pattern. When errors are brought to our attention, we make every effort to correct and post a revision as soon as possible. We suggest you check windhamfabrics.com for pattern updates and to test the pattern prior to making the project. Test templates first, before cutting all the pieces. Free projects are not for resale.



Technicolor Tiles

PIECING INSTRUCTIONS

STRIP SET A ASSEMBLY:

1. Sew (1) 2 ½" x WOF **Fabric I** strip onto either side of (1) 4 ½" x WOF **Fabric A** strip lengthwise. Press toward **Fabric I**.
2. Repeat to create (4) identical Strip Set A, each measuring 8 ½" x WOF.
3. From Strip Set A, subcut (64) 2 ½" x 8 ½" units. Label as Unit A.

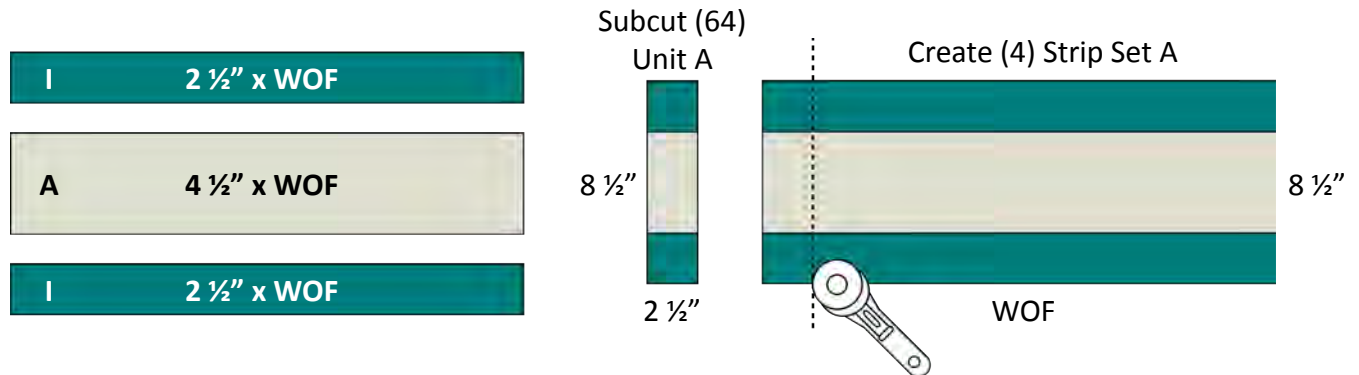

STRIP SET B ASSEMBLY:

4. Sew (1) 2 ½" x WOF **Fabric F** strip onto either side of (1) 4 ½" x WOF **Fabric G** strip lengthwise. Press toward **Fabric G**.
5. Repeat to create (4) identical Strip Set B, each measuring 8 ½" x WOF.
6. From Strip Set B, subcut (64) 2 ½" x 8 ½" units. Label as Unit B.

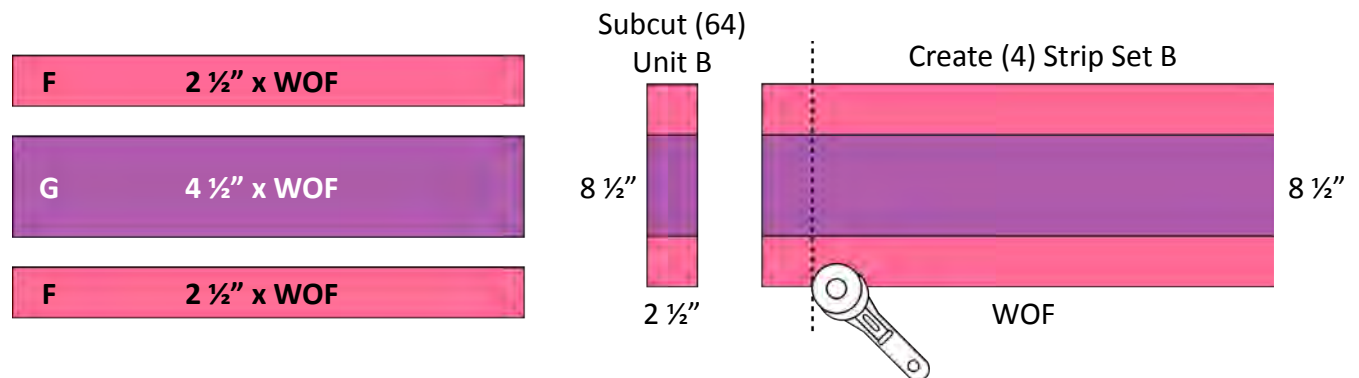

BLOCK ASSEMBLY:

7. To create Block Colorway 1, arrange the following pieces:
 - a. (4) 4 ½" **Fabric E** squares.
 - b. (1) 8 ½" **Fabric B** square.
 - c. (4) Unit A.
 - d. (4) Unit B.
8. Arrange the pieces gathered above as shown in the diagram, and sew. Arrows indicate pressing instructions. Once complete, Block Colorway 1 should measure 16 ½" x 16 ½" unfinished.
9. Repeat to create (4) Block Colorway 1.



Technicolor Tiles

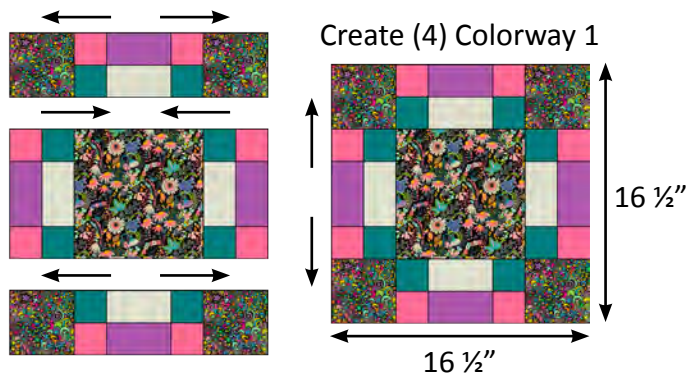
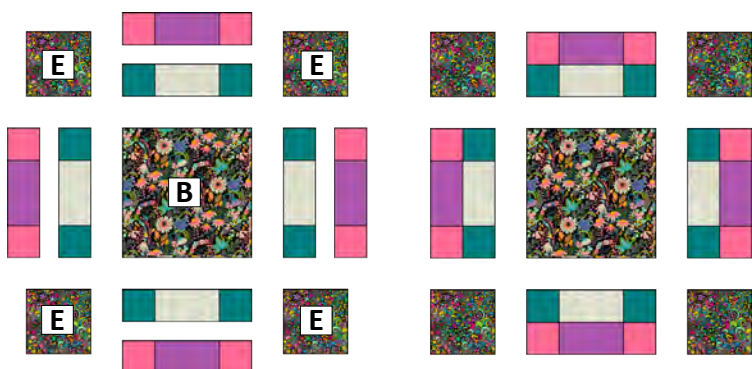

10. To create Block Colorway 2, arrange the following pieces:

- a. (4) 4 1/2" Fabric K squares.
- b. (1) 8 1/2" Fabric D square.
- c. (4) Unit A.
- d. (4) Unit B.

11. Arrange the pieces gathered above, and sew referencing Step 8. Once complete, Block Colorway 2 should measure 16 1/2" x 16 1/2" unfinished.

12. Repeat to create (8) Block Colorway 2.

13. To create Block Colorway 3, arrange the following pieces:

- a. (4) 4 1/2" Fabric E squares.
- b. (1) 8 1/2" Fabric C square.
- c. (4) Unit A.
- d. (4) Unit B.

14. Arrange the pieces gathered above, and sew referencing Step 8. Once complete, Block Colorway 3 should measure 16 1/2" x 16 1/2" unfinished.

15. Repeat to create (4) Block Colorway 3.

Create (8) Colorway 2

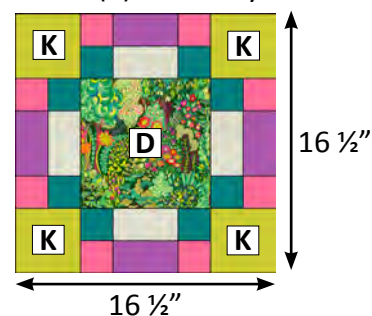

Create (4) Colorway 3

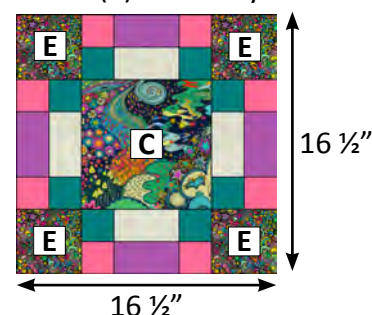

SASHING ASSEMBLY:

16. Create a strip set for the sashing by sewing (3) 2" x WOF Fabric A strips and (2) 6 1/4" x WOF Fabric H strips together, alternating between Fabrics A and H as shown in the diagram.

17. Repeat to create (3) identical strip sets, each measuring 16 1/2" x WOF.

18. From the strip sets, subcut (40) 2 1/2" x 16 1/2" units for sashing. Set units aside for quilt assembly.

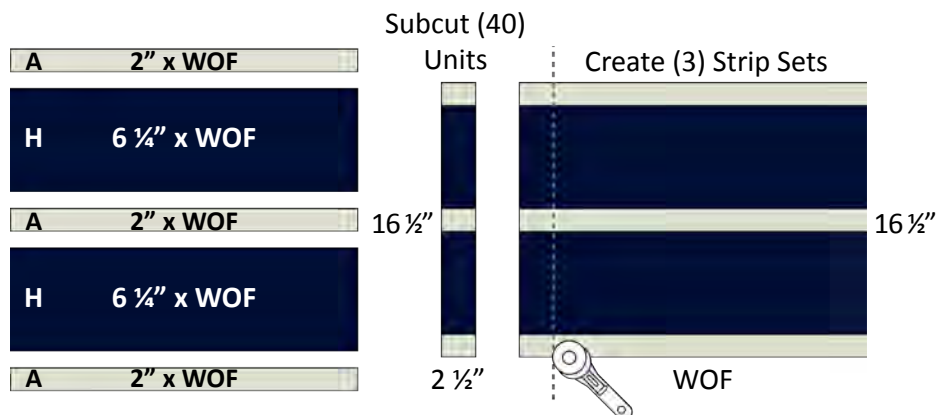



Technicolor Tiles

QUILT ASSEMBLY:

19. Create horizontal block rows. Arrange Block Colorways 1-3 in a 4 x 4 grid as shown in the diagram. Place (1) 2 ½" x 16 ½" pieced sashing unit vertically in between each block and at either end of each block row.
20. Create horizontal sashing rows. Arrange (4) 2 ½" x 16 ½" pieced sashing units and 2 ½" cornerstone squares from **Fabrics F** and **J**. Place horizontal sashing rows between each block row and at the top and bottom of the quilt top. Alternate between **Fabrics F** and **J** cornerstones as shown in the diagram.
21. Sew horizontal block rows together, pressing seams toward the pieced sashing units.
22. Sew horizontal sashing rows together, pressing seams toward the pieced sashing units.
23. Sew horizontal block and sashing rows together to complete quilt top assembly. The quilt top should measure 74 ½" x 74 ½" unfinished.

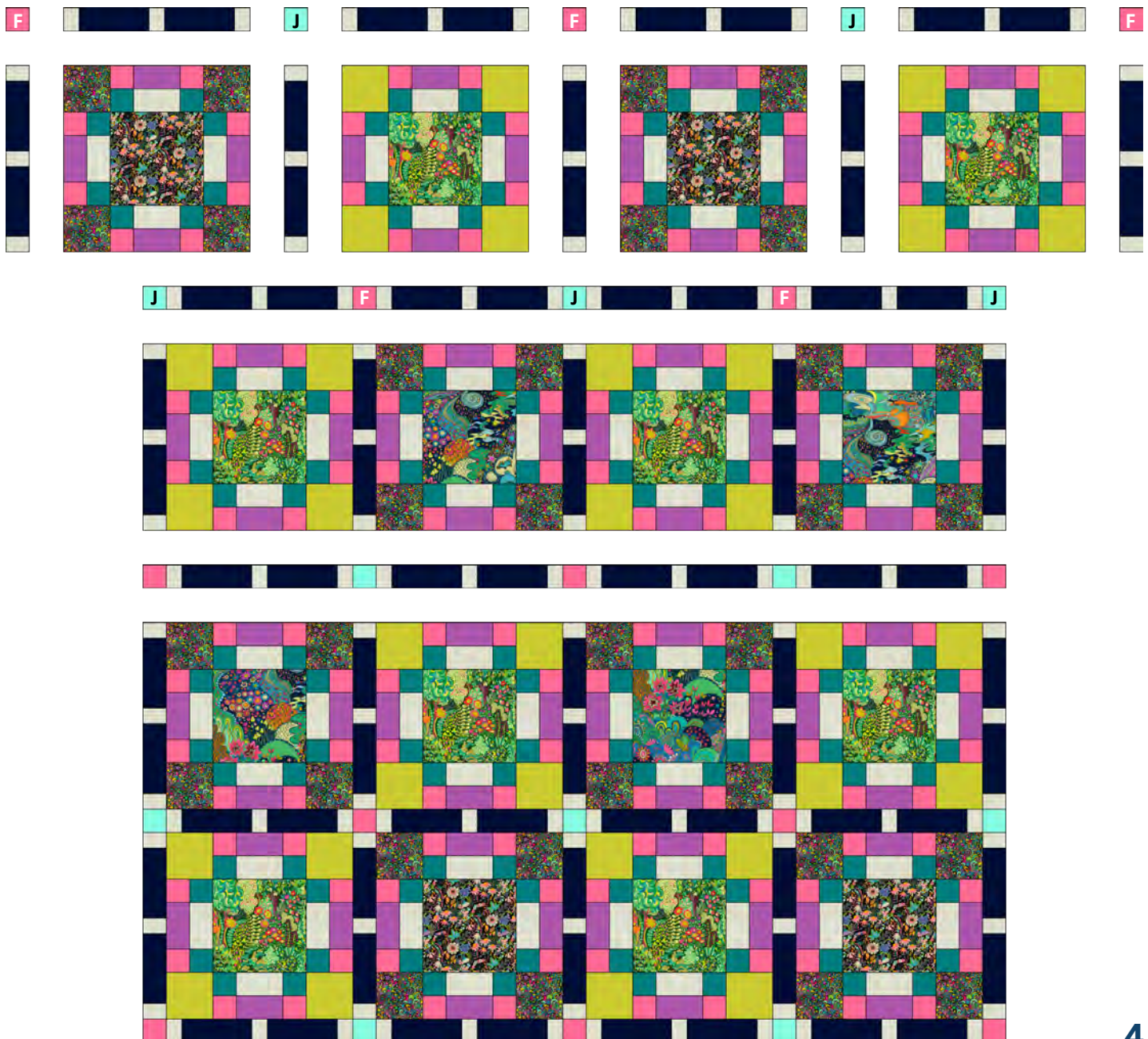



Technicolor Tiles

FINISHING THE QUILT:

24. Sandwich quilt top with batting and backing. Baste quilt layers together using your preferred method. Quilt as desired.
25. Create binding using (8) **Fabric A** 2 ¼" x WOF strips.
26. Attach binding using your preferred method.

