

# On the Town Shopper

Designed by LJ Simon

Featuring the Girls Night Out Collection by Terri Degenkolb for Whimsicals

Size: 15 1/2" x 15" x 5"





FREE  
PROJECT

**PLEASE NOTE:** BEFORE MAKING YOUR PROJECT, CHECK FOR ANY PATTERN UPDATES AT [WINDHAMFABRICS.COM](http://WINDHAMFABRICS.COM)'S FREE PROJECTS SECTION.

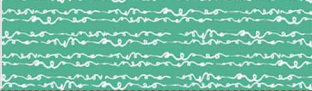

# On the Town Shopper

Page 2

FABRIC	SKU NUMBER	YARDAGE
	43073-2 Grey	3/4
	43077-6 Green	1
	40171-27 Black/Copper (Artisan Cotton)	1/2
	43073-1 Cream ** optional - for charms	1/8 or Fat 1/8

## Additional Requirements:

- 1 yard Pellon® 72f Peltex Ultra Firm 2-sided Fusible
- (1) Magnetic clasp closure
- 1/2 yard Woven fusible
- (1) Pair 24" long leather purse handles. Our sample used handles from [www.bagpurseframes.com](http://www.bagpurseframes.com).
- (1) short beaded chain (optional for charms)
- Embroidery Floss in a teal color to match



## Cutting:

### 43073-2 Grey

- Cut (2) 16" x 13 1/2" rectangles for front and back of shopper outside
- Cut (1) 15" x 11" rectangle for top flap

### 43077-6 Green

- Cut (2) 16" x 18" rectangles for lining
- Cut (1) 8" x 16" rectangle for inside pocket
- Cut (2) 5 1/2" x 15 1/2" rectangles for sides
- \*\*Save leftovers to use for fussy cut shoe charms

### 40171-27 Black/Copper

- Cut (1) 16" x 9 1/2" rectangle for bottom
- Cut (2) 5 1/2" x 15 1/2" rectangles for side panels

### Pellon® 72f

- Cut (1) 15 1/4" x 35 1/2" rectangle for body
- Cut (1) 14 1/2" x 5 1/8" rectangle for top flap
- \*\*Save leftovers to use for fussy cut shoe charms

### Woven fusible

- Cut (2) 5 1/2" x 15 1/2" rectangles for side panels

### 43073-1 Cream

- Fussy cut (3-4) shoes for charms





# On the Town Shopper

## Assembly:

All seam allowances are 1/4" wide

1. Take one piece of the shopper front and sew it to the long side of the bottom. Press seam open and 1/8" topstitch on each side of seam.
2. Take the other side of the shopper and reverse the orientation of the print and sew it to the other end of the bottom. Diagram 1 Press seam open and 1/8" topstitch on each side of seam. Fold in half matching top edges and press a crease to show middle of the bottom. Set aside.
3. Take one side of the lining and with right side facing down, turn over the bottom edge 1/4" and press. Repeat for the other side.
4. Take the pocket piece and fold in half lengthwise with right sides together. Sew around the 3 open sides leaving a 3" opening for turning. Clip the corners, turn and press. Slip stitch the opening closed. Diagram 2
5. Place pocket, with the folded edge at the top, onto one side of the lining 3" from the top edge and centered from side to side. Pin in place. Edge stitch around the sides and bottom. Reinforce at the top edge on each side. Diagram 3
6. With right sides together, pin one side of the lining to the top edge of the shopper outside. Machine stitch. Press the seam allowance toward the lining and edge stitch. Repeat for the other side. Diagram 4
7. With right sides together, match the folded edges of the lining with shopper outside bottom crease line. Pin in place. Sew around all the pinned outside edges. Clip the corner seam allowance, Turn and press the edges flat.

Diagram 1



Diagram 2

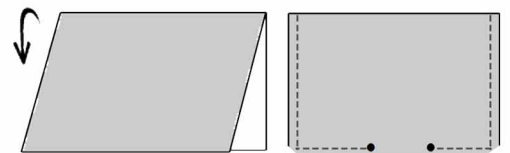

Diagram 3

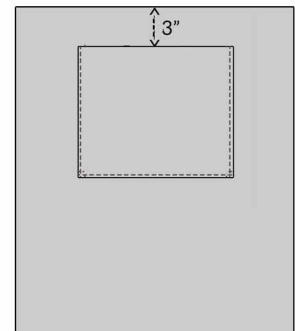

Diagram 4





# On the Town Shopper

8. Take the large piece of the Pellon® and slide it carefully into the envelope you have created with the outside and lining of the shopper. It should fit very snugly and will take a little effort to slide it into place. If possible, slide the seam allowance to the lining side of the Pellon®. Diagram 5

9. Once the the Pellon® is in place, slipstitch the opening closed and press the shopper to adhere the Pellon® following the manufacturer's recommended instructions. Diagram 6

10. Take the shopper flap rectangle and with wrong sides together, machine stitch the ends. Clip the corners, turn and press flat.

11. Take the Pellon® rectangle and slide it into the flap. Push to the folded edge so that you have at least 1/4" of fabric extending beyond the Pellon® edge. Touch the iron lightly to each end but do not press the center. This is only to secure it in place.

12. Placing the magnetic clasp - on the wrong side of the flap, mark the center of the flap about 1" from the edge. With a seam ripper, cut small slits through the wrong side of the flap and the Pellon® for the progs but DO NOT cut through the outside of the flap. Slide the clasp into place and bend the progs over the cover plate. You do NOT want to see the clasp on the flap outside.

13. Press the flap to adhere the Pellon® as instructed for the shopper body.

14. With the lining side facing up, place the opened end at the top edge of the lining side with the pocket, centered from each side. Machine stitch Diagram 7

15. Press flat up and edge stitch top of shopper. Diagram 8

16. Add the other half of the magnetic clasp to the opposite side of the shopper body. Place 1" from the top edge and centered from each side. Make 2 small slits with a seam ripper through all layers for the progs. Attached so that the clasp is on the outside of the shopper.

17. Take the outside panels and adhere the woven fusible to the wrong side following the manufacturer's recommended instructions.

18. Take one piece of the outer and lining side panels. With right sides together, stitch around all sides leaving a 3" opening for turning at the bottom. Clip corners, turn and press flat. Slipstitch the opening closed. Repeat for the other side to form the side panels.

19. With lining side up, take one side panel and match center of the short side with the center of the shopper bottom. Base into place and then machine edge stitch. Repeat for the other side. Diagram 9

Diagram 6

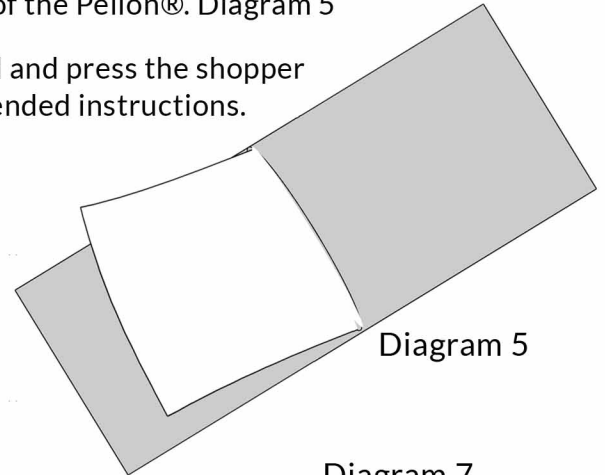
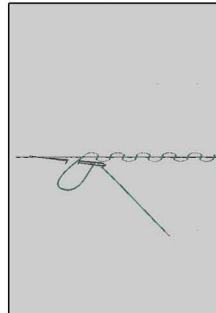
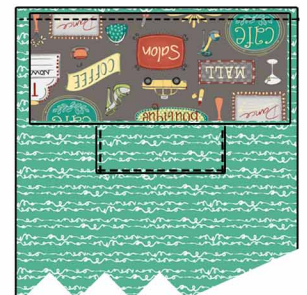

Diagram 5

Diagram 7



Magnetic snap

Diagram 8

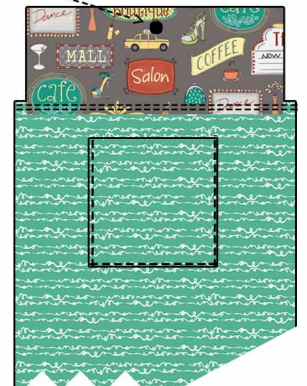
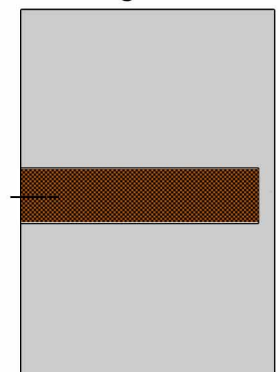

Diagram 9







# On the Town Shopper

Diagram 10

- 20. Take the side panel and match the top edge to the top edge of the shopper. Diagram 10  
Base one side in place then machine edge stitch from top to bottom, sewing as close as you can to the bottom edge. Repeat for the other side of the panel. Then repeat for the other side of the shopper.

*\*\*Note: the basting is highly recommended to hold the pieces in place. The Pellon® is very stiff and difficult to handle so the basting will help to keep everything in place as you sew.*



- 21. On one side of the shopper, mark the center. Measure 2 1/2" in each direction from the center and mark. This is where the inside edge of the handle will be placed. At that point, measure 4" from the top edge. This is where the bottom edge of the handle will be placed. Diagram 11  
If you are using leather handles with perforated holes, hand stitch the handles to the bag using embroidery floss. Repeat for the other side of the bag. If you do not have perforated holes, you can use (2) metal brads on each end to hold the handles in place.

Diagram 11

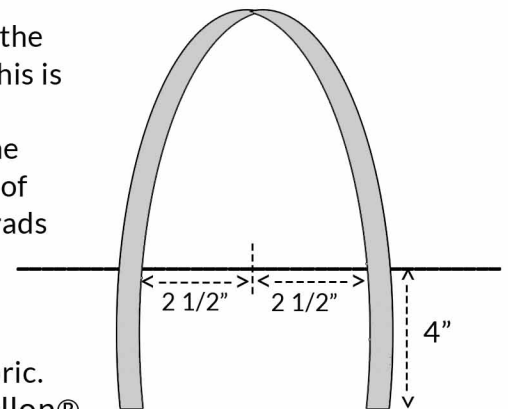

- 22. Optional Charms  
Fussy cut a rectangle around 3-4 shoes from the 43073-1 Cream fabric. Pin each shoe rectangle side by side on top of a rectangle of Pellon®. Cut a rectangle from the lining fabric the same size as the Pellon® and with wrong side facing the Pellon®, place on the opposite side from the shoes like a sandwich. Press the 3 layers together.
- 23. Using a tight zigzag stitch, sew around each shoe. Cut out carefully around each shoe\*. Punch a hole at the top of each shoe, run the beaded chain through each hole and then around one side of the shopper handle. *\*Note: Should you cut some of the zigzag stitch, sew over the area again with the same tight zigzag.*

