

People Flourish Pillow

Designed by LJ Simon

Featuring the Flourish Collection by Mia Whittemore

Size: 13" x 19"



FREE
PROJECT











PLEASE NOTE: BEFORE MAKING YOUR PROJECT, CHECK FOR ANY PATTERN UPDATES AT WINDHAMFABRICS.COM'S FREE PROJECTS SECTION.



People Flourish Pillow

Page 2

This pillow was inspired by the flower pots that looked like hats - diversity is the spice of life!

FABRIC	SKU NUMBER	YARDAGE
	43513-4 Blue	Fat 1/8
	43507-X Multi	Fat 1/4
	43509-5 Green	Fat 1/8
	43512-3 Berry	Fat 1/8
	43511-4 Blue	Fat 1/8
	43510-3 Berry	Fat 1/8
	37098-62 Marionberry	Fat 1/8
	37098-11 Cream (or like color)	Scrap
	37098-8 Taupe (or like color)	Scrap
	37098-10 Burnt Umber (or like color)	Scrap
	31835S White Solid	Fat 1/4

Additional Requirements:

- 1 sheet of Steam-A-Seam 2® or 2 sided fusible web of your choice or fabric glue
- Fat Quarter of a white woven fusible interlining (or enough to cover 19 1/2" x 13 1/2" for white pillow face)
- Embroidery floss - we used Aurifil colors:
 - #2530 for mouths, #5013 and 6010 for eyes, #5013 and 2625 hair for girl 1, #6735 hair for girl 2,
 - #2225 hair for girl 3, #1285 hair for girl 4
- 19" x 13" oblong pillow stuffer

Special Notes:

- All seam allowances are 1/4" wide
- Please read all instructions before you start your project.



People Flourish Pillow

Page 3

Cutting:

43507-X Multi Flower pots

Cut (1) each of the coordinating flower pot that was used on each girl or a pot of your choice. Fussy cut so that you have at least a full 1/8" to needle turn under when applied to the pillow.

43510-3 Berry Triangles

Cut (2) 25 1/2" x 2 1/2" strips for top and bottom borders

Cut (2) 19 1/2" X 2 1/2" strips for left and right side borders

Cut (1) 11 3/4" x 13 1/2" rectangle for pillow back / piece 2

Cut (1) 12" x 13 1/2" rectangle for pillow back / piece 1

31835S White Solid

Cut (1) 15 1/2" x 9 1/2" rectangle for pillow face

37098-62 Marionberry Solid

Cut (2) 25 1/2" x 1" strips for pillow face flat insert

Cut (2) 19 1/2" x 1" strips for pillow face flat insert

37098-11 Cream Solid

Cut (1) head and neck strip using template

37098- 8 Taupe Solid

Cut (2) head and neck strips using template

37098-10 Burnt Umber Solid

Cut (1) head and neck strip using template

43513-4 Blue Herringbone

Cut (1) top using template A

43509-5 Green Floral

Cut (1) top using template A

43511-4 Blue Gumdrops

Cut (1) top using template A

43512-3 Berry Plaid

Cut (1) top using template B

White fusible interlining

Cut (1) 19 1/2" x 13 1/2" rectangle for pillow face



People Flourish Pillow

Page 4

Assembly:

1. Take the head, neck and top pieces and carefully turn back seam allowance. The technique used is a needle turn so it is important you take the time to finger press seam allowances toward wrong side for sewing. The 2 sided webbing is used as a way to hold each piece in place as you arrange them on the solid white rectangle following the layout template provided. You do not have to cut to the exact size, just enough to hold the piece you are putting onto the pillow face in place. You can also use fabric glue instead if you like. Always follow manufacturer's recommended instructions before you use the product.
2. Place each piece one by one sewing the heads and necks of the girls first, then their garments and lastly their hats. Follow the pillow picture to be sure you overlap the arms of garments so the ends are covered by the girl on each side.



Girl 1

Girl 2

Girl 3

Girl 4

3. After you have appliued all the pieces, then you will embroider all the hair and faces. For girl 1 and 4, a straight stitch was used to create the hair. The hair on girl 2 is a chain stitch and for girl 3 the hair is made with french knots. Have fun and feel free to make your own expressions or change hairstyles!
4. After all the applique and embroidery is complete, clean up the threads on the back carefully. Set aside.
5. With the wrong sides together, fold the solid marionberry strips together lengthwise. With right sides together, place the strip onto the border strip. Center the top strip on the pillow face and machine stitch to strip. Repeat this step for all 4 border strips.

Diagram 1



Diagram 1



People Flourish Pillow

Page 5

Mitered Corners:

6. With the wrong sides together, center the top strip on the pillow face and machine stitch to pillow face stopping $\frac{1}{4}$ " from the end on each side. Be sure to back stitch so the end is secure and will not unravel. Repeat this same step for the other three sides. *Diagram 2*
7. Take the pillow face and fold in half on the diagonal with right sides together. Line up the 2 borders so they are even. Pin firmly in place. Mark the 45 degree angle diagonal line formed by the fold through the border with a pencil or marking pen. *Diagram 3*.
8. Sew from the stitch line out toward the end of the border, directly on the line. Backstitch at the beginning and end. Trim seam allowance to $\frac{1}{4}$ ". Unfold and make sure there are no gaps in the inner corner and that the border lies flat. Repeat for the other 3 sides. Press all seams flat. *Diagram 4*
For more help you can follow the tutorial from Craftsy where there are step by step photographed pictures.
<https://www.craftsy.com/blog/2013/03/mitered-quilt-borders>
9. Take the white woven fusible and with wrong sides together, adhere it to the pillow face following the manufacturer's recommended instructions. This will keep your pillow inside nice and clean and also keep the background looking white.

Back:

10. Take $12" \times 13 \frac{1}{2}"$ rectangle of the backing and on one short side, fold fabric toward the wrong side $\frac{1}{4}"$ and press flat. Fold an additional $1 \frac{1}{2}"$ and press flat. Edge stitch open edge. *Diagram 5 / piece 1*
11. Take $11 \frac{3}{4}" \times 13 \frac{1}{2}"$ rectangle and on one end, fold fabric toward the wrong side $\frac{1}{4}"$ and press flat. Fold an additional $\frac{1}{4}"$ and press flat. Edge stitch open edge. *piece 2*
12. With right sides facing down, overlap the piece 2 on top of the piece 1 so that the final length is $19 \frac{1}{2}"$. Pin the sides together to hold in place. The overlap is approximately 3".
13. Add an edge stitch on each end to hold the overlapped sections in place. *Diagram 6*

Finishing:

14. With right sides together, place face on back and sew around the outside of the pillow shell on all 4 sides. Clip corner seam allowance and cover stitch seam allowance edges or add a tight zigzag stitch to prevent raveling. Turn and press.
15. Insert the oblong pillow form to complete your pillow.

Note: Special thanks to Wendy Sheppard for creating the hair and embroidered faces on the pillow

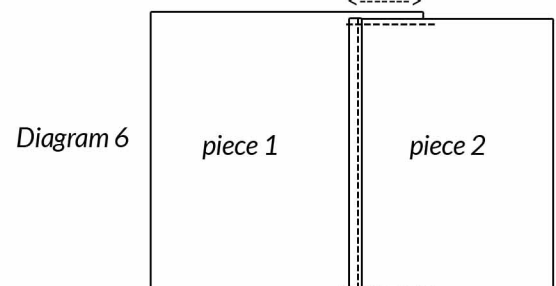
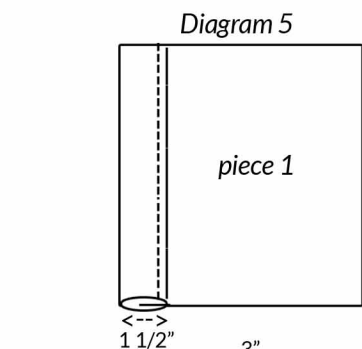
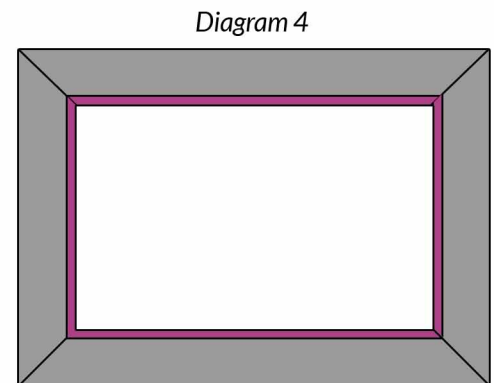
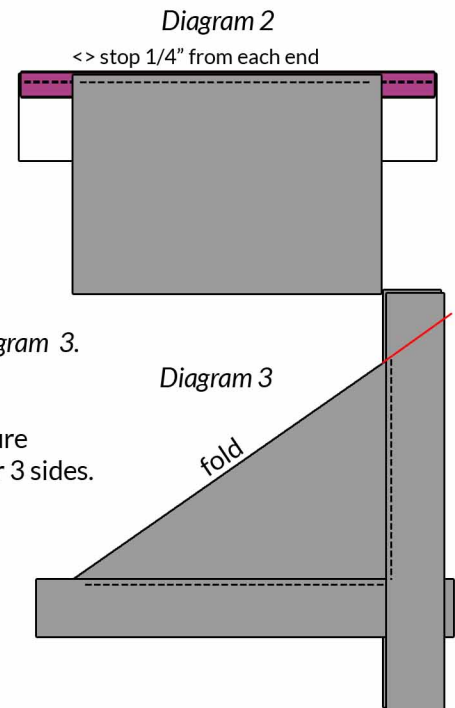



People Flourish Pillow

Page 6



Girl 1
Hair - Straight Stitch



Girl 2
Hair - Chain Stitch



Girl 3
Hair - French Knots



Girl 4
Hair - Straight Stitch

Detail of faces for embroidery on appliqued heads



People Flourish Pillow

Page 7

HEAD, NECK AND BODY TEMPLATES

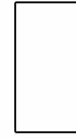
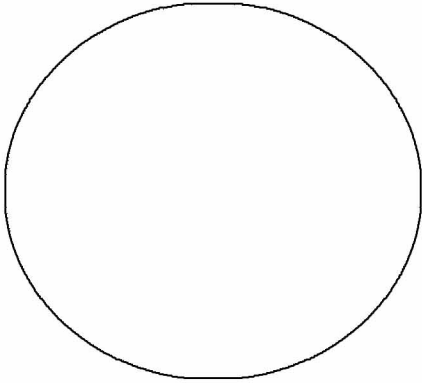

NO seam allowance has been included on templates

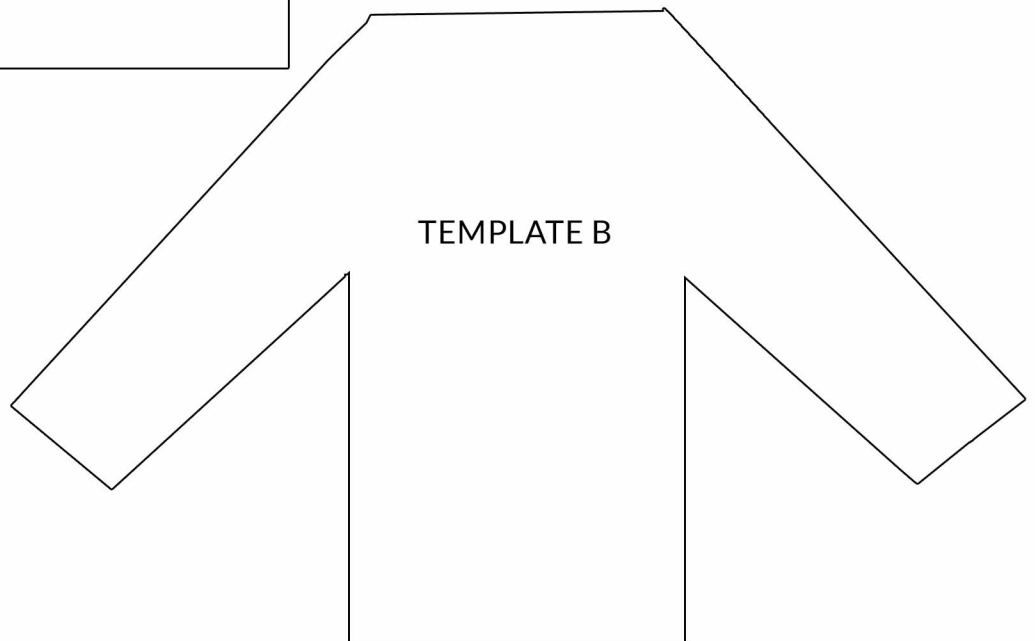
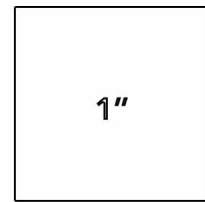
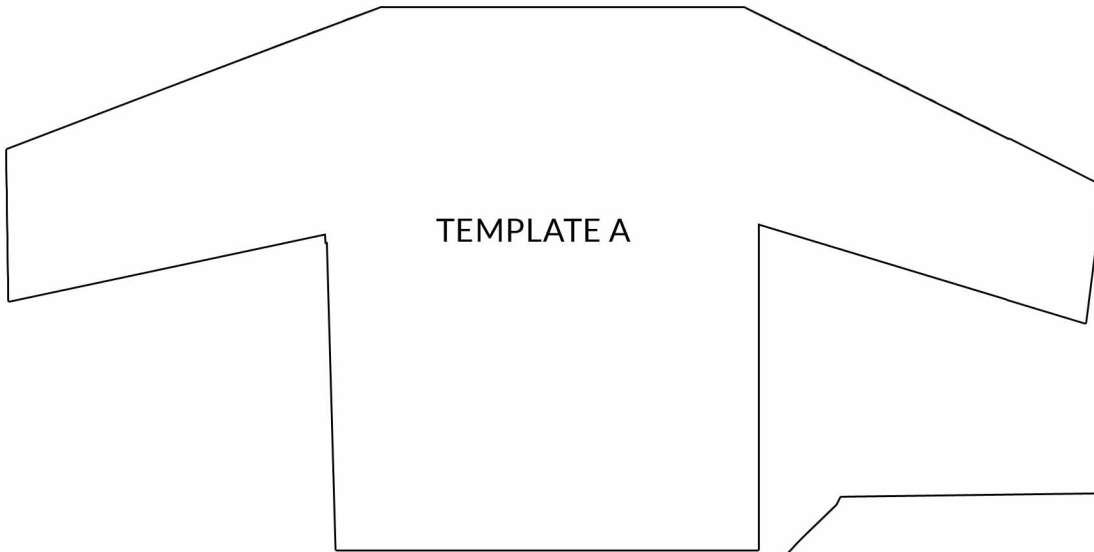



People Flourish Pillow

Page 8

LAYOUT GUIDE LEFT SIDE

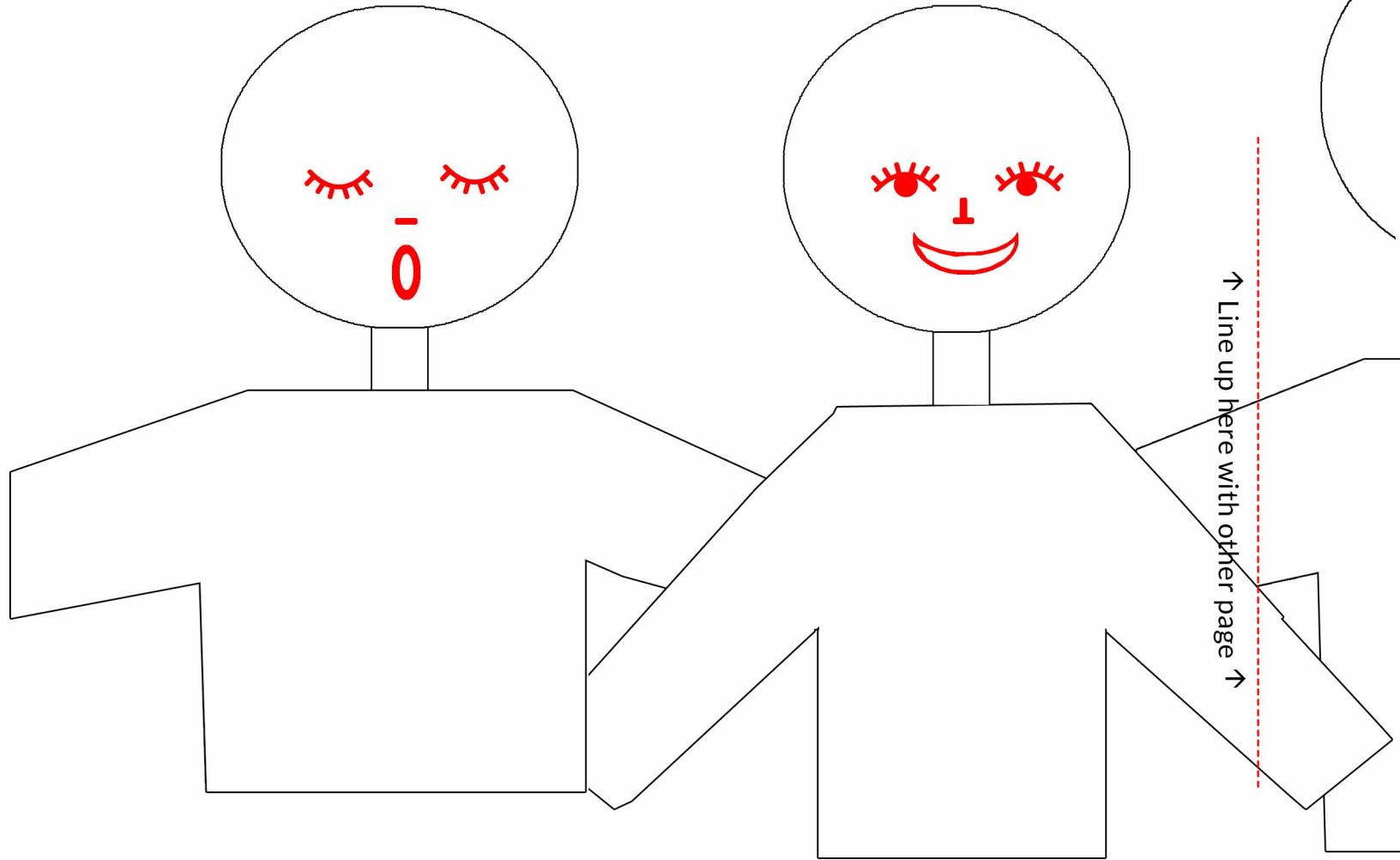



People Flourish Pillow

Page 9

LAYOUT GUIDE RIGHT SIDE

